

**FAMILIA N°. 057 Tornillo Hexagonal de Acero Cincado
DIN 933 Clase 8.8 Grado 5**

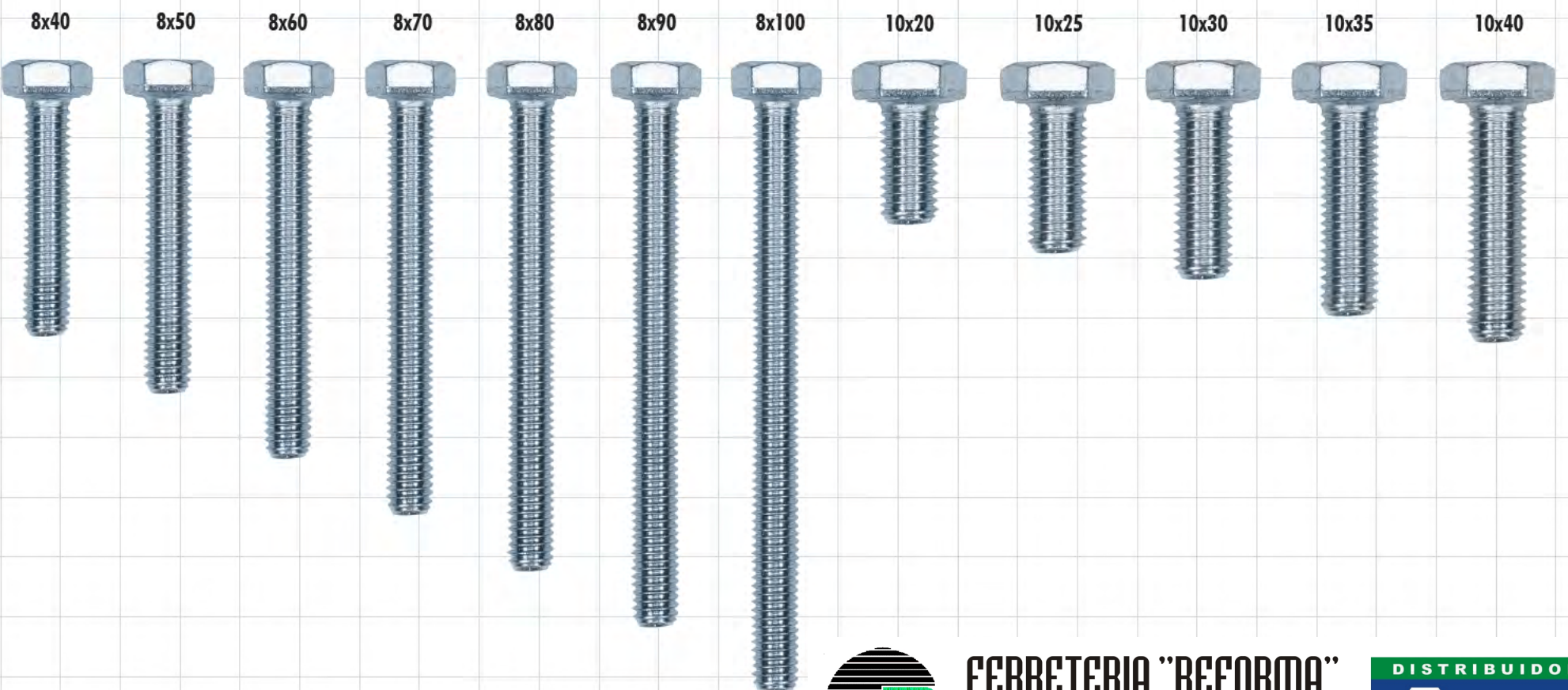

FERRETERIA "REFORMA"
MAURICIO MUNGUÍA ANAYA
 VENUSTIANO CARRANZA # 1
 SAYULA, JAL. C.P. 49300
 TEL/FAX 01-342-4220165
mmuam@prodigy.net.mx

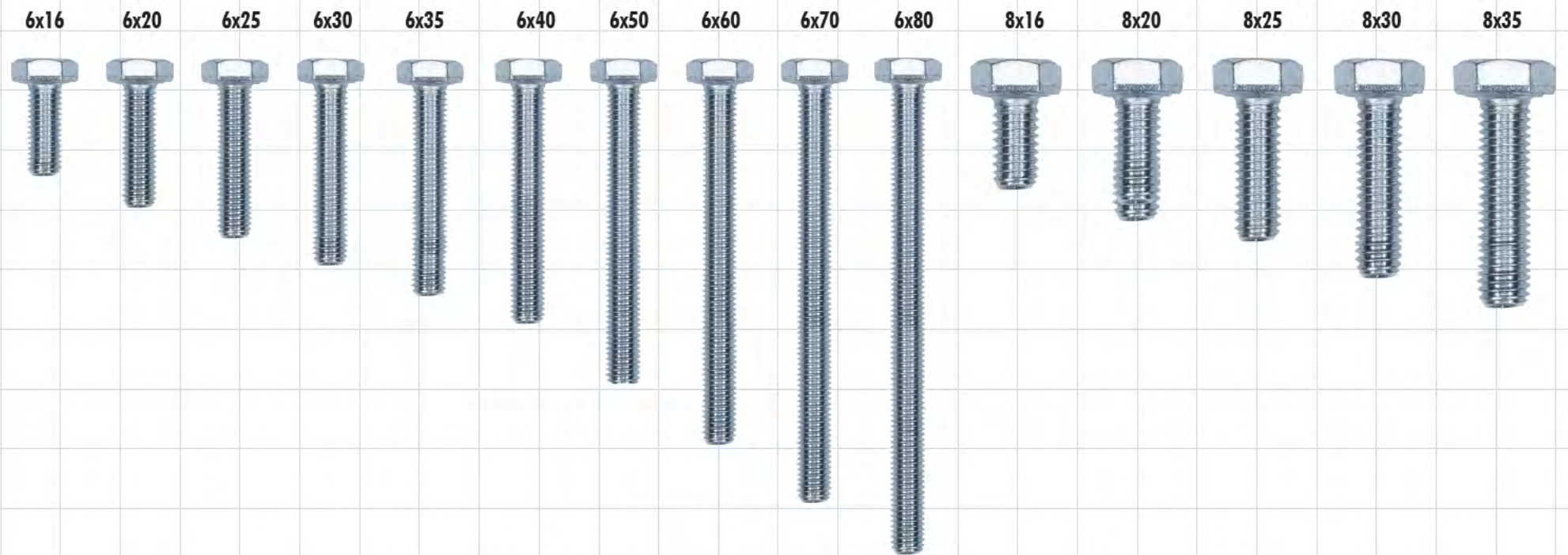
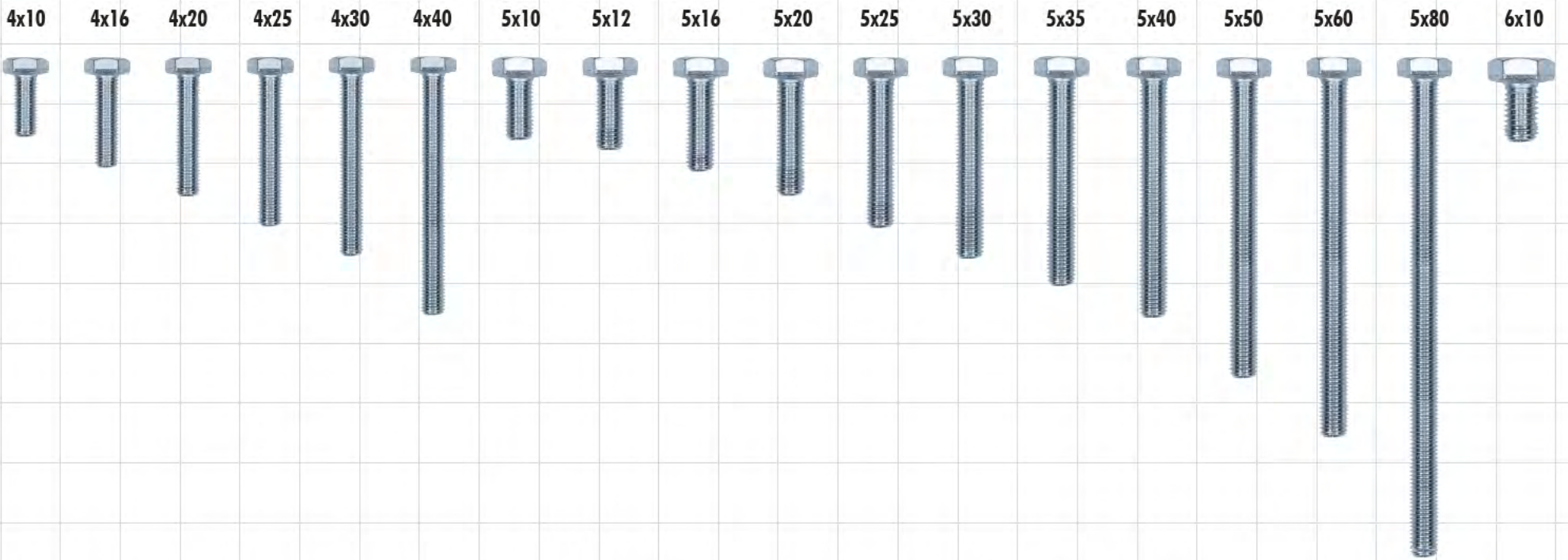

¡¡ UN MUNDO DE HERRAMIENTAS !!

FAMILIA No. 407 Rondana Plana Biselada de Acero Cincado DIN 125

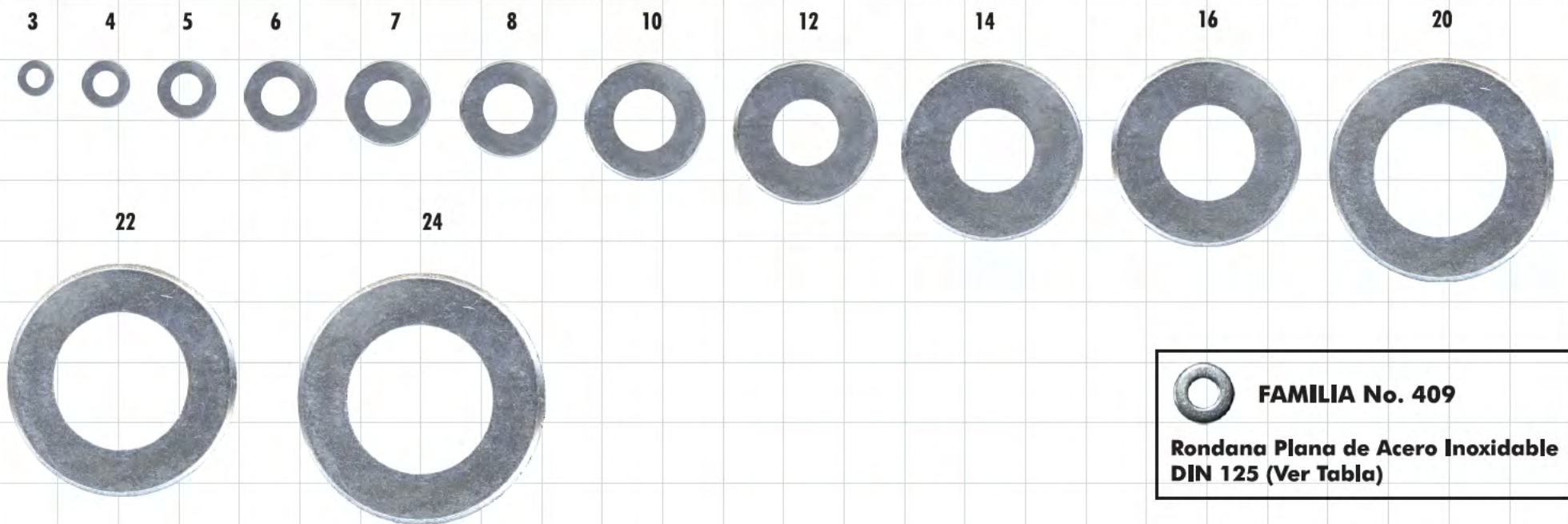

 **FAMILIA No. 409**
Rondana Plana de Acero Inoxidable
DIN 125 (Ver Tabla)

FAMILIA No. 411 Rondana Plana Ancha de Acero Cincado DIN 522

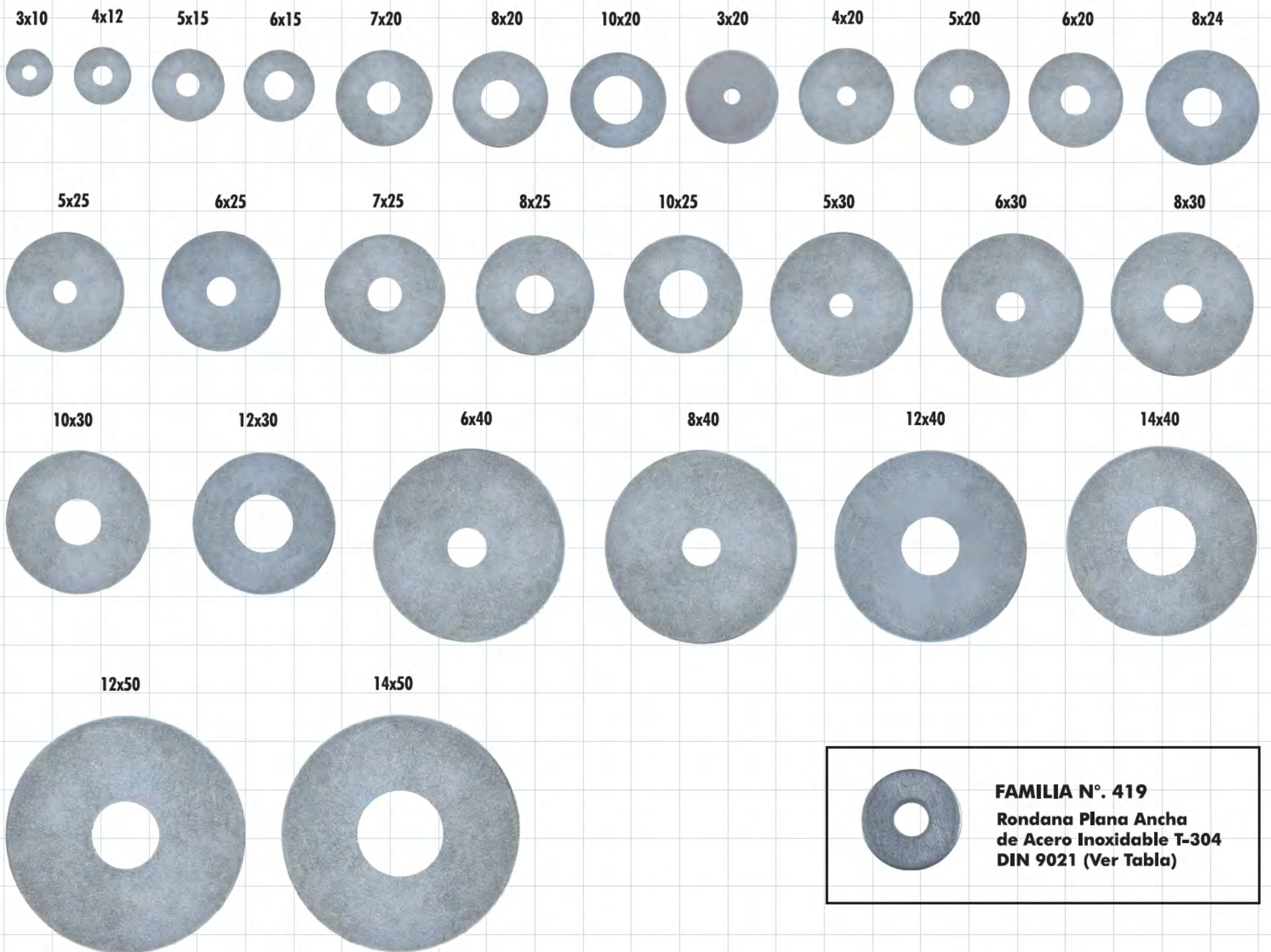

 **FAMILIA N°. 419**
Rondana Plana Ancha
de Acero Inoxidable T-304
DIN 9021 (Ver Tabla)

FAMILIA No. 441 Rondana de Presión (Tipo Grower) de Acero Cincado DIN 127

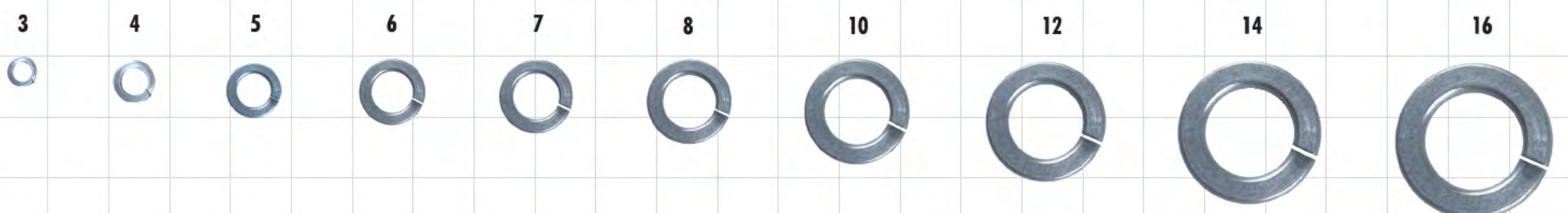

FAMILIA No. 421 Rondana Plana de Poliamida DIN 125



FAMILIA No. 493 Rondana de Acero Fosfatado Dentado Interior DIN 6789

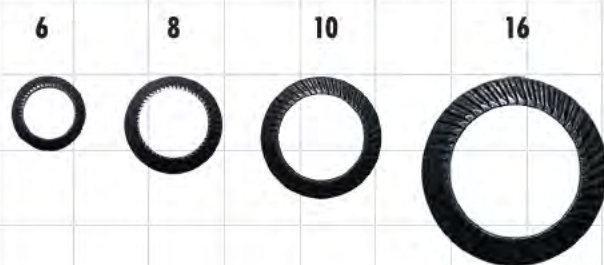

FAMILIA No. 455 Rondana Cónica de Acero Latonado DIN 17670



FAMILIA No. 447 Rondana de Presión (Tipo Grower) de Acero Inoxidable

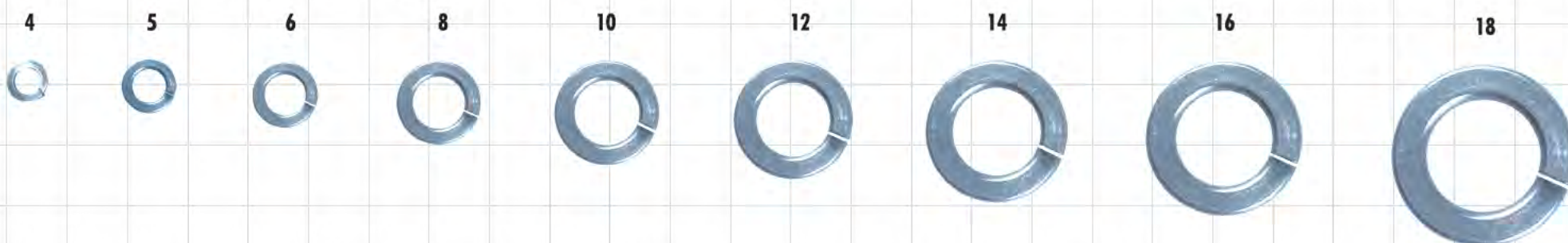

FAMILIA No. 429 Rondana de Acero Cincado con Dentado Exterior DIN 6798

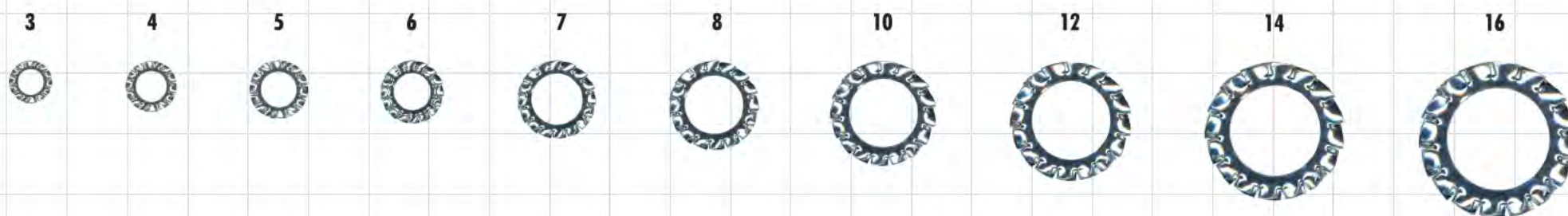

FAMILIA No. 435 Rondana Ondulada de Acero Cincado DIN 1378

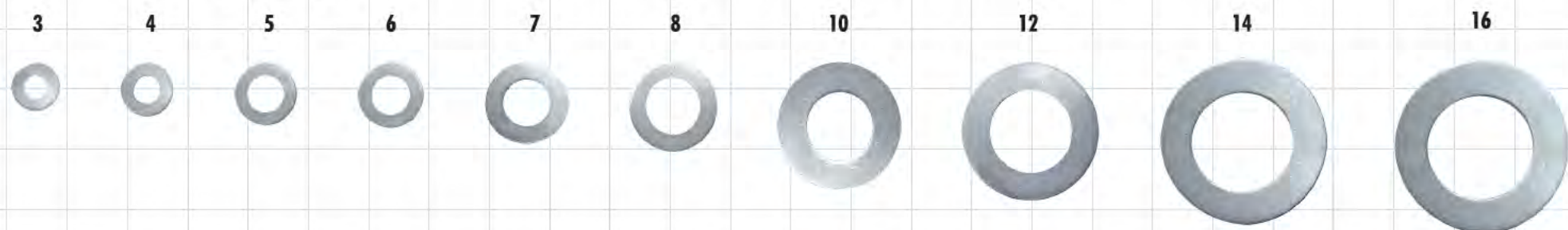

FAMILIA No. 458 Rondana Cónica de Acero Latonado Negro DIN 17670



FAMILIA N°. 419 Rondana Plana Ancha de Acero Inoxidable T-304 DIN 9021



FAMILIA No. 409 Rondana Plana de Acero Inoxidable T-304 DIN 125

Art. No.	Para Tornillo diámetro (mm)	Exterior (mm)	Grosor
00419 4	4	12	1
00419 5	5	15	1.6
00419 6	6	18	1.6
00419 8	8	24	2
00419 10	10	30	2.5
00419 12	12	40	3

Art. No.	Para Tornillo diámetro (mm)	Exterior (mm)	Grosor
00409 2	2	5	0,3
00409 3	3	7	0,5
00409 4	4	9	0,8
00409 5	5	10	1
00409 6	6	12	1,6
00409 7	7	14	1,6
00409 8	8	16	2
00409 10	10	20	2

Art. No.	Para Tornillo diámetro (mm)	Exterior (mm)	Grosor
00409 12	12	24	2,5
00409 14	14	28	2,5
00409 16	16	30	3
00409 18	18	34	3
00409 20	20	37	3
00409 22	22	39	3
00409 24	24	44	4

**FAMILIA N° 317 Tuerca Hexagonal de Acero Cincado
DIN 934 Clase 8.8 Grado 5**

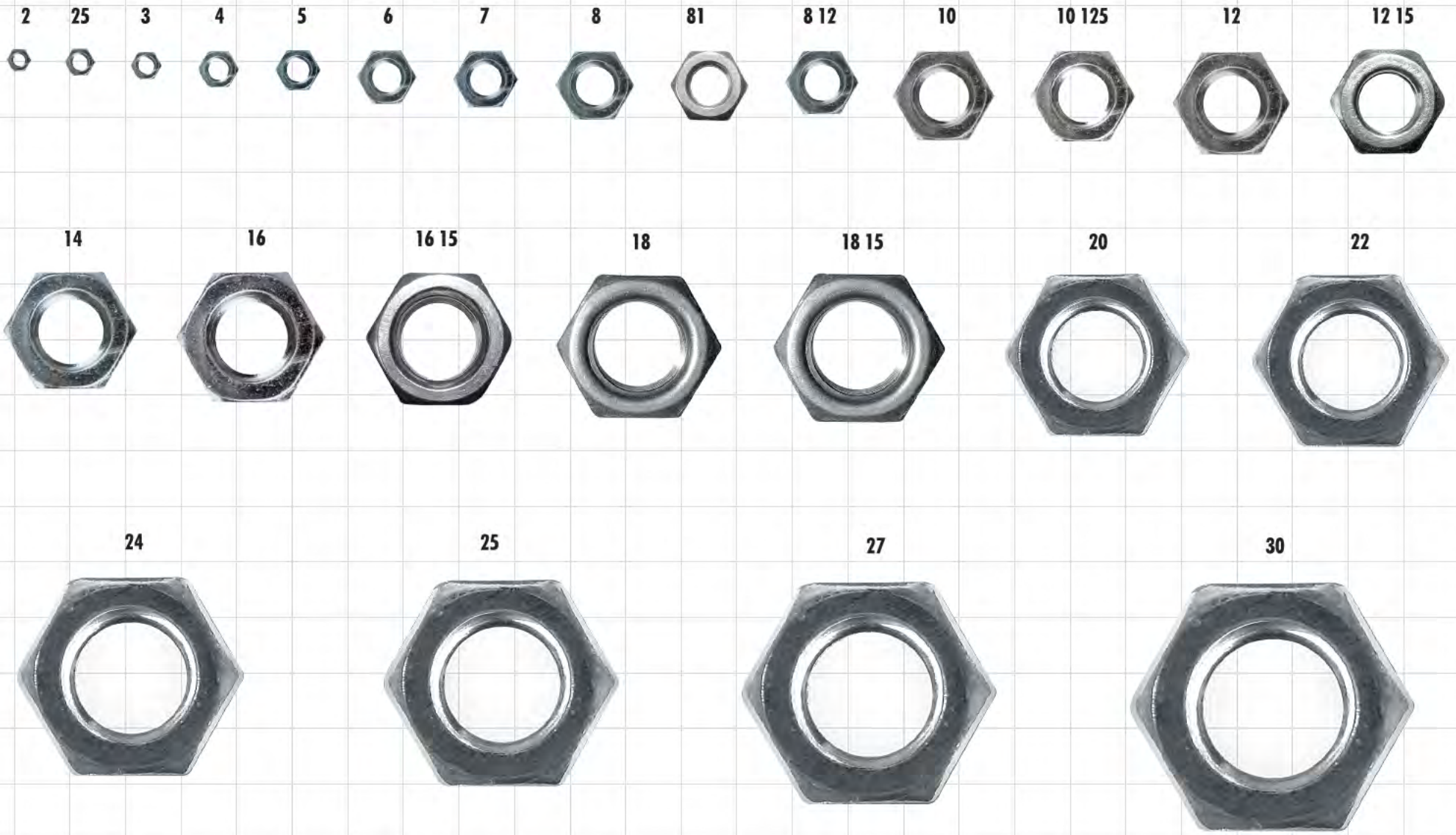

**FAMILIA N° 368 Tuerca de Seguridad de Acero Cincado con Inserto de
Poliuretano DIN 934 Clase 8.8 Grado 5**

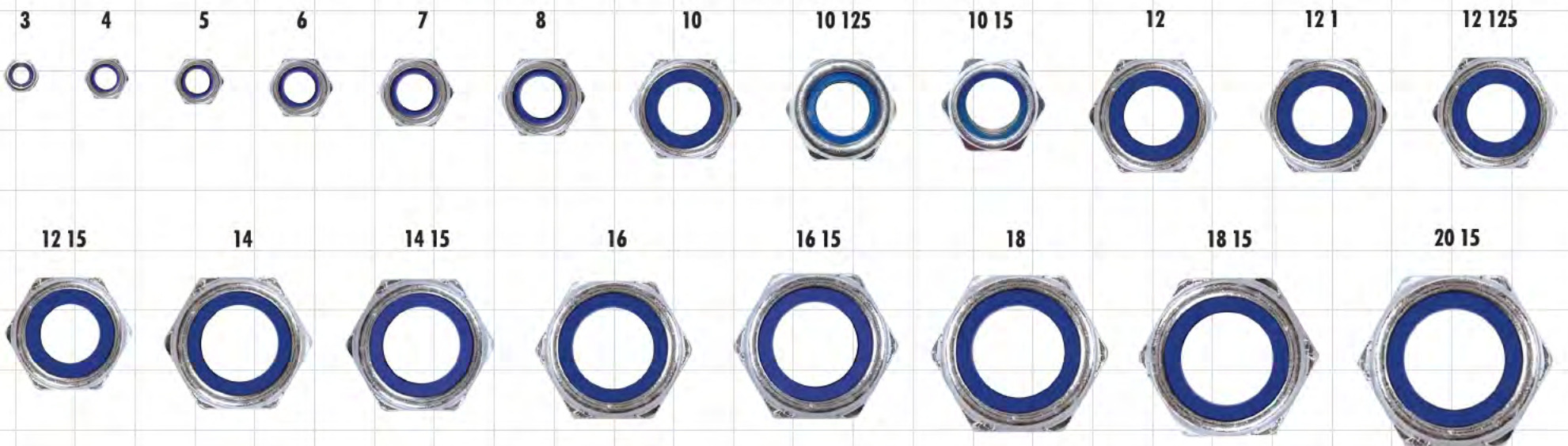

**FAMILIA No. 370 Tuerca de Seguridad de Acero Bicromatado con
Inserto de Poliuretano Clase 10.9 Grado 8**

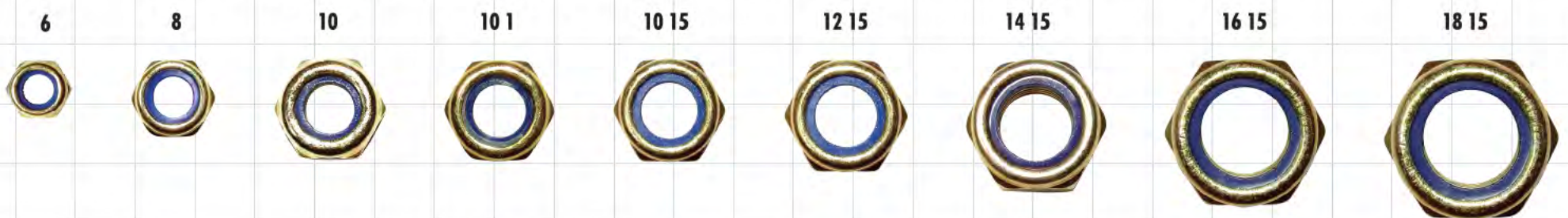

**FAMILIA N° 324 Tuerca Hexagonal de Acero Bicromatado
Clase 10.9 Grado 8**



FAMILIA N° 376 Tuerca de Acero Cincado con Inserto para Madera DIN 1624



FAMILIA No. 391 Tuerca de Seguridad de Acero Inoxidable T-304 con Inserto de Poliuretano DIN 985



FAMILIA No. 394 Tuerca de Seguridad de Acero Bicromatado con Rondana Astriada Integrada Clase 8.8 Grado 5



FAMILIA N° 322 Tuerca Hexagonal Acero Inoxidable T-304 DIN 934



FAMILIA No. 366 Tuerca Hexagonal de Acero Cobreado DIN 14441 Clase 8.8 Grado 5

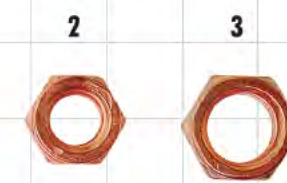

FAMILIA No. 365 DIN 14440

FAMILIA No. 381 Tuerca Enjaulada de Acero Cincado



FAMILIA No. 385 Tuerca Soldable de Acero Cincado



FAMILIA N° 357 Tuerca Colador para Volkswagen de Acero Cincado DIN 917



**FAMILIA N° 250 Birlo de Acero Fosfatado
DIN 939 Clase 8.8 Grado 5**



**FAMILIA N° 255 Prisionero Allen de Acero Fosfatado
DIN 913 Clase 8.8 Grado 5**

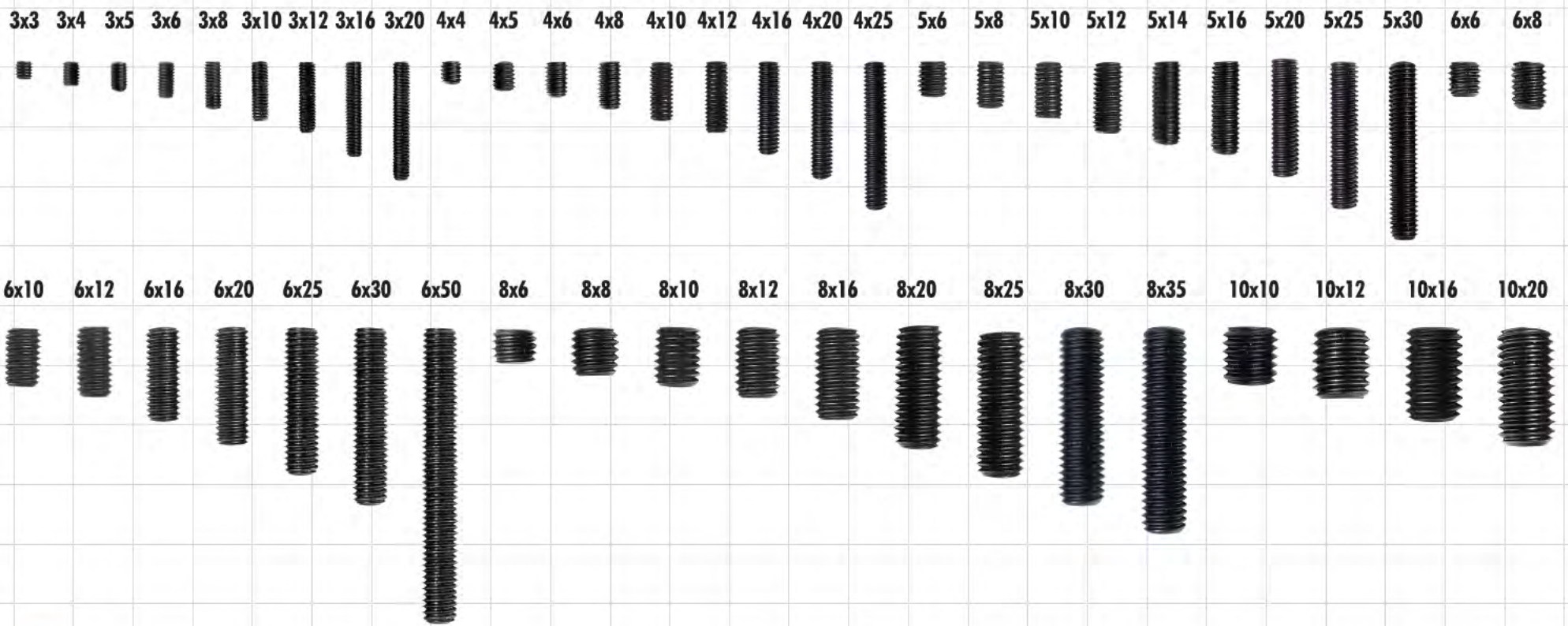

**FAMILIA N° 240 Tapón Carter Paso 1.5
para Llave 19 mm.**



**FAMILIA N° 243 Tapón Carter Ford Paso 1.5
para Llave 13 mm.**



**FAMILIA N° 268 Rótula de Acero Cincado con Tuerca y Cuerda
Integrada Clase 8.8 Grado 5**

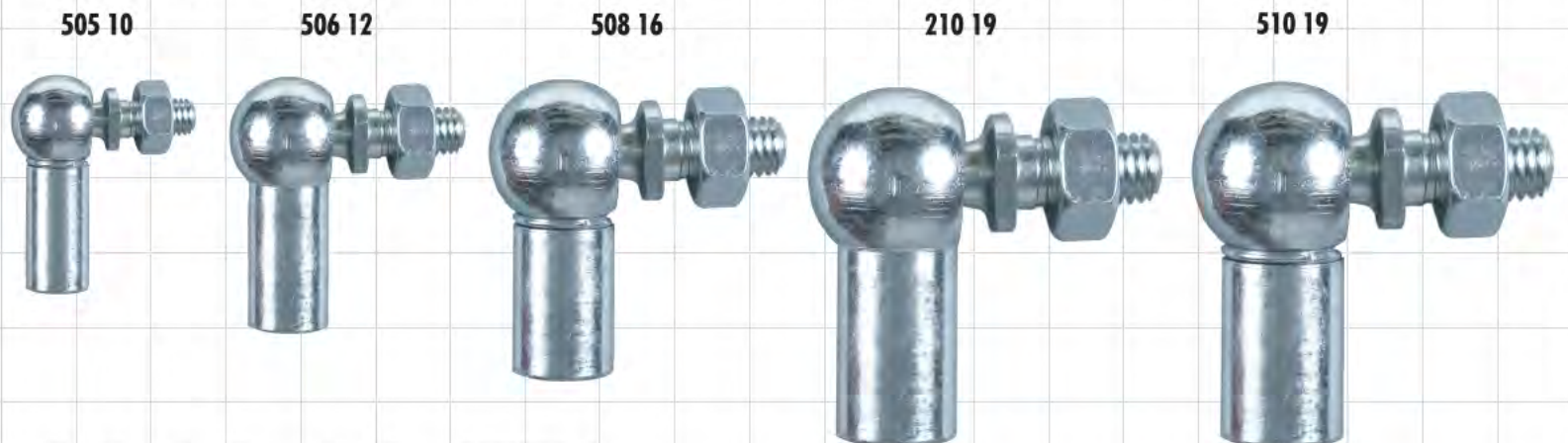
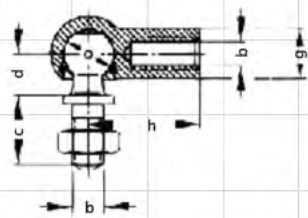

Art. No.	a (mm)	bxc (mm)	d (mm)	g (mm)	h (mm)	Forma
00268 505 10	8	5x10	9	8	22	AS
00268 506 12	10	6x12	11	10	25	AS
00268 508 16	13	8x16	13	13	30	AS
00268 210 19	16	10x19	16	16	35	A
00268 510 19	16	10x19	16	16	35	AS

FAMILIA N° 134 0 Pija Negra de Ala Ancha (Phillips) de Acero Cincado DIN 7981

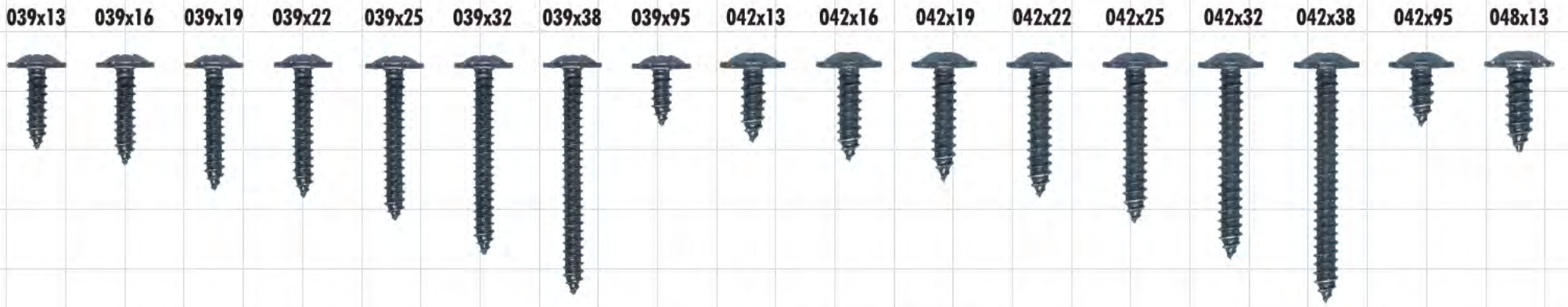

FAMILIA N° 134 Pija Negra Cabeza Fijadora (Phillips) de Acero Cincado DIN 7981

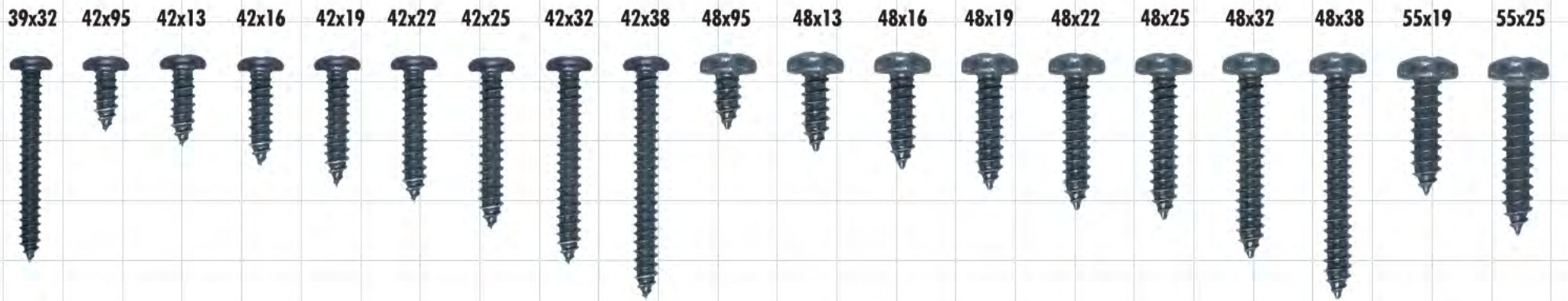

FAMILIA N° 115 Pija Cabeza Fijadora (Phillips) de Acero Cincado DIN 7981

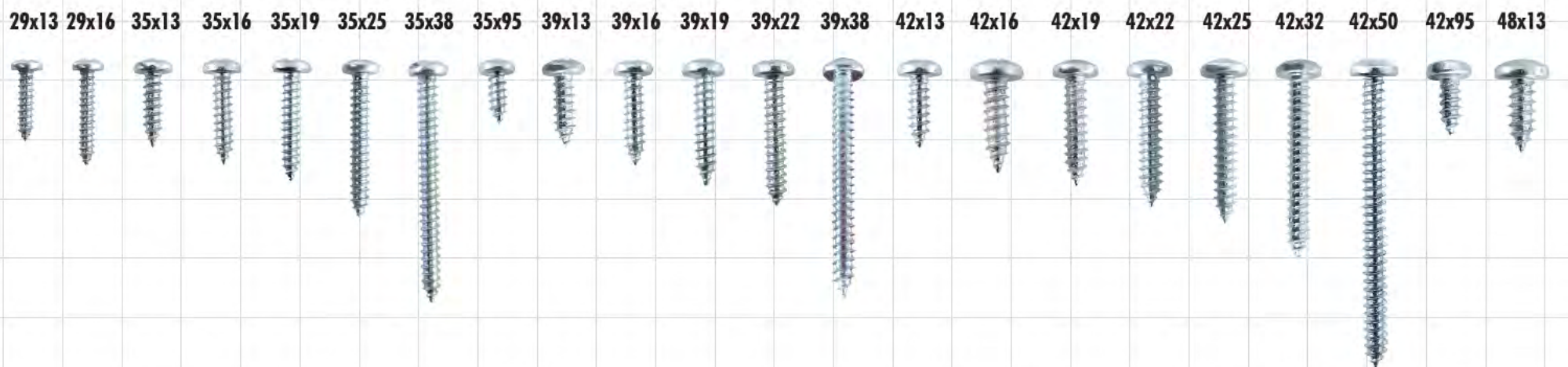

FAMILIA N° 114 Pija Hexagonal de Acero Cincado DIN 7976





FAMILIA N.º 117 Pija Cónica Cabeza de Gota (Phillips) de Acero Cincado DIN 7983

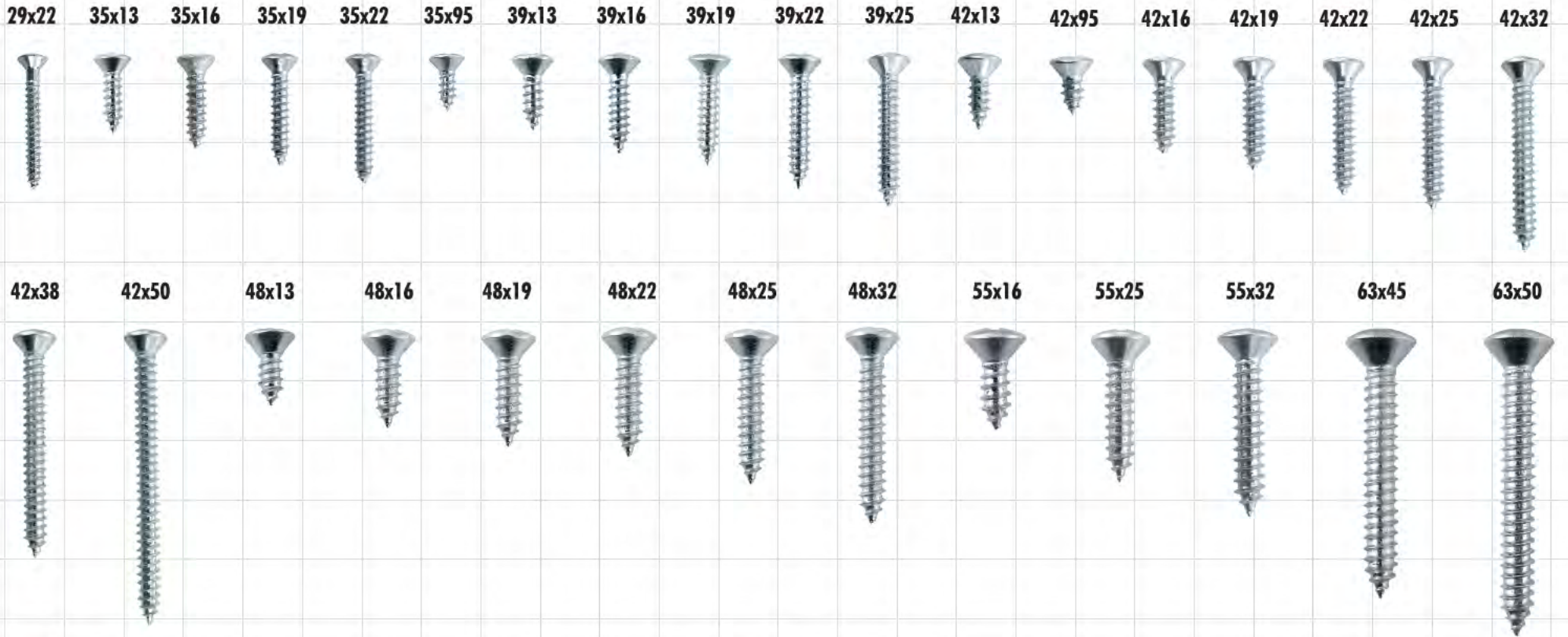

FAMILIA N.º 137 Pija Negra Cónica Cabeza de Gota (Phillips) de Acero Cincado DIN 7983

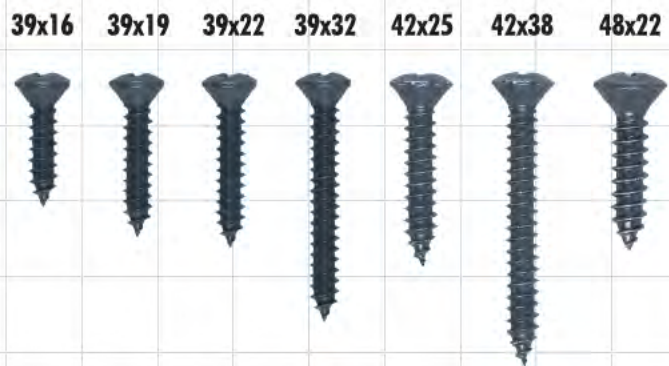

FAMILIA N.º 129 Pija Hexagonal de Acero Cincado con Rondana Móvil Integrada



FAMILIA N.º 215 Pija Cónica Fresadora Punta de Broca con aleta Fijadora de Acero Bicromatado



FAMILIA N.º 219 Pija Cónica Fresadora Punta de Broca con Aleta Fijadora para Punta AW de Acero Cadmizado DIN 50021



FAMILIA N.º 207 Pija Cónica Fresadora Punta de Broca Autoperforante de Acero Cincado



FAMILIA N.º 130 Pija Hexagonal de Acero Cincado con Rondana Fija Integrada

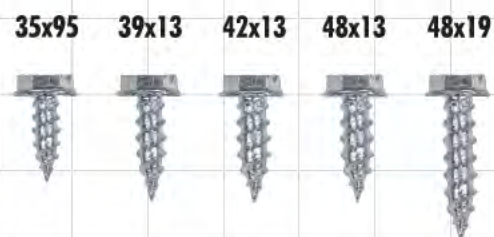

FAMILIA N° 206 Pija Punta de Broca de Acero Cincado Autoperforante para Punta AW, ASSY

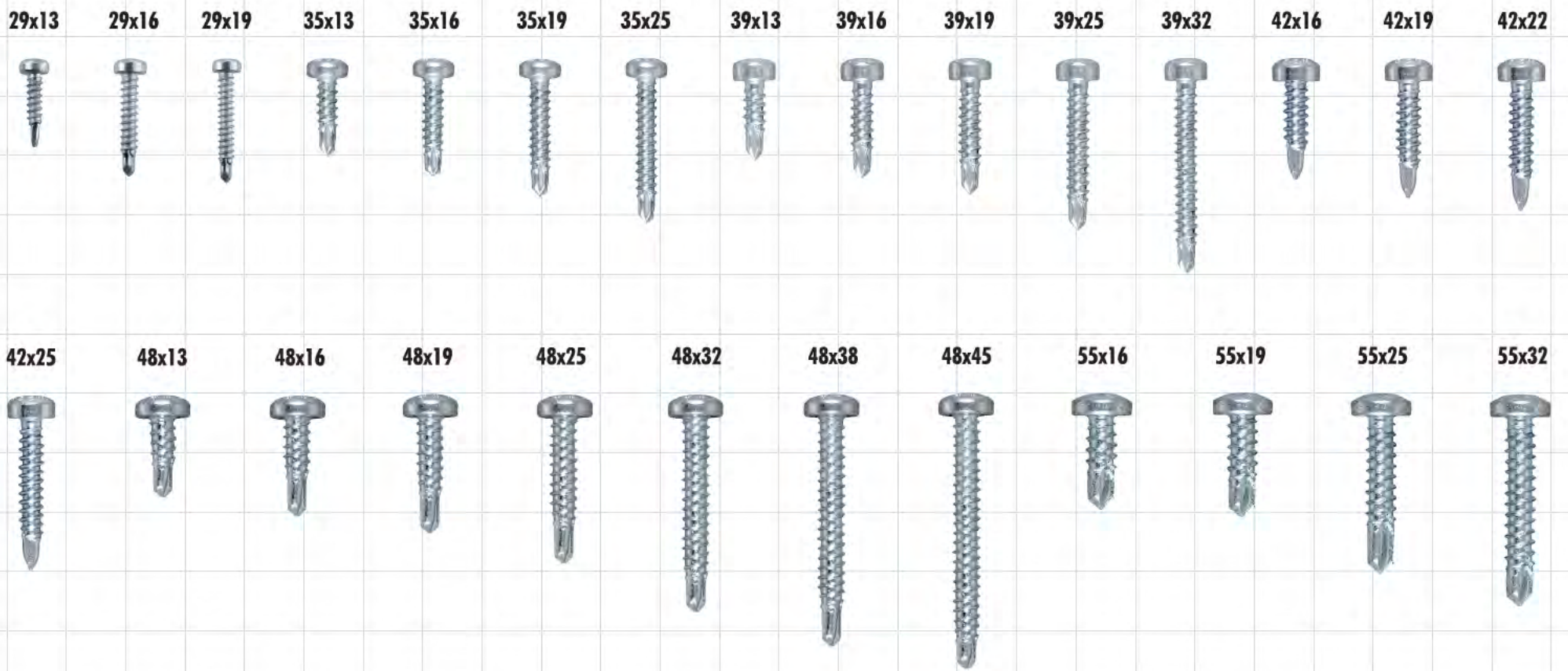

FAMILIA N° 189 Pija Cabeza de Trompeta para Madera y Tablaroca de Acero Fosfatado

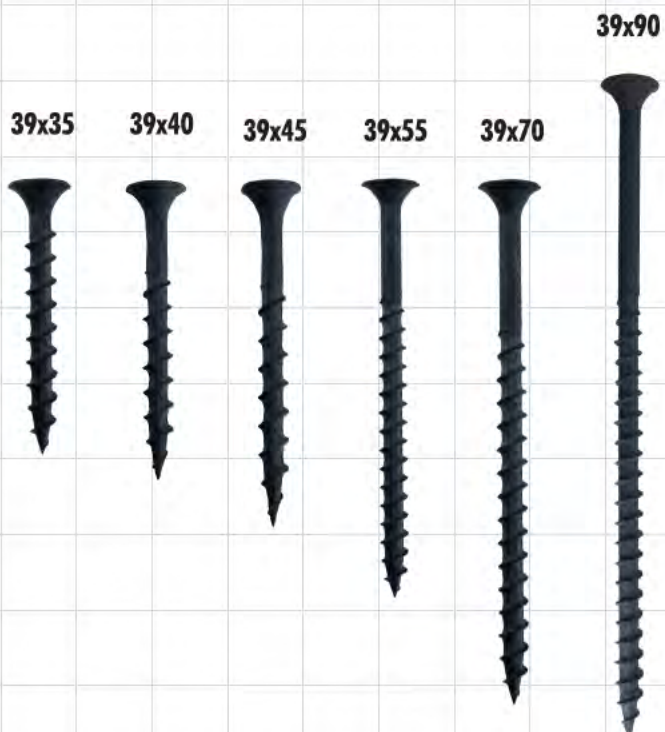
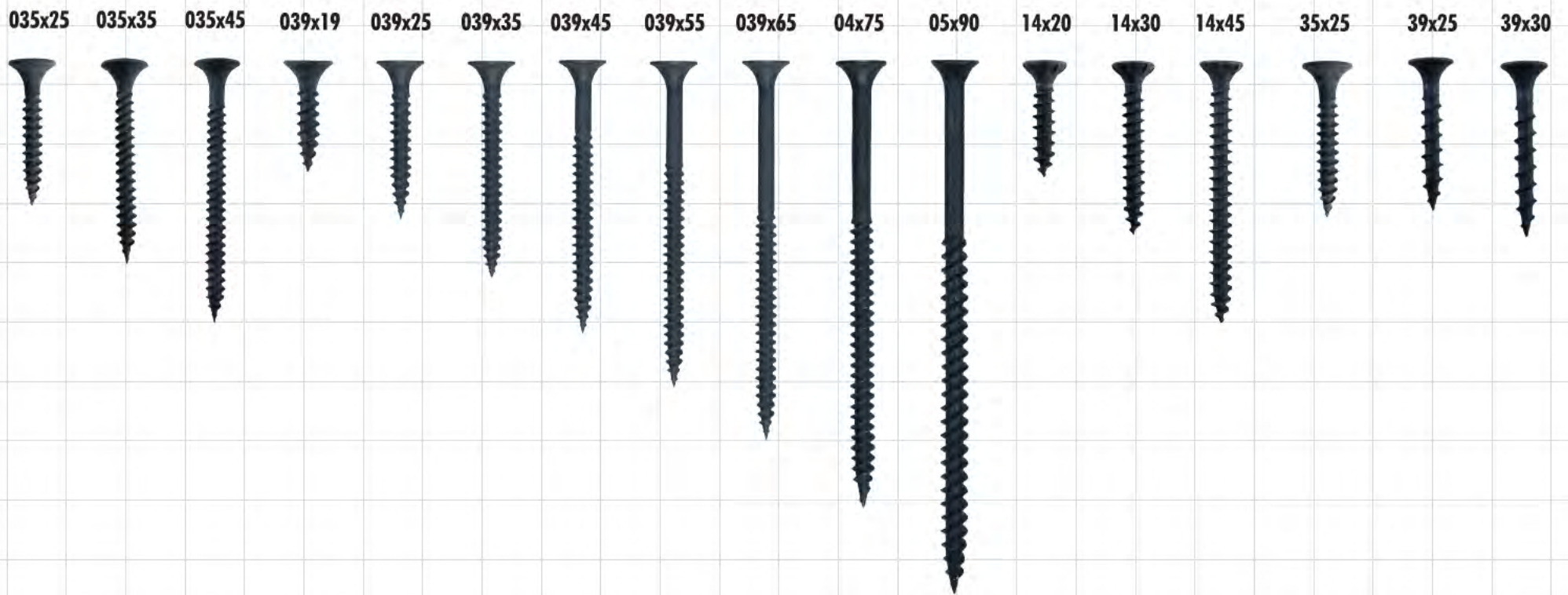

FAMILIA N° 214 Pija Autoperforante de Acero Cincado con Rondana Estancada DIN 7504 K



FAMILIA No. 202 Tapón de P.V.C. para Pijas de Cabeza Fijadora



FAMILIA No. 470 Chaveta Milimétrica de Acero Cincado Zebra

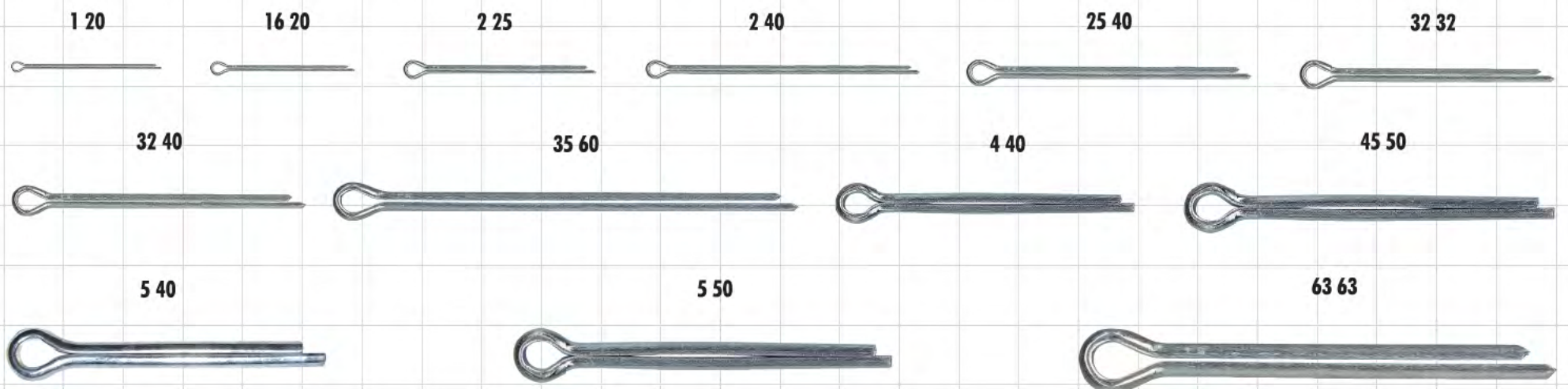

FAMILIA No. 470 Chaveta en Pulgadas de Acero Cincado Zebra

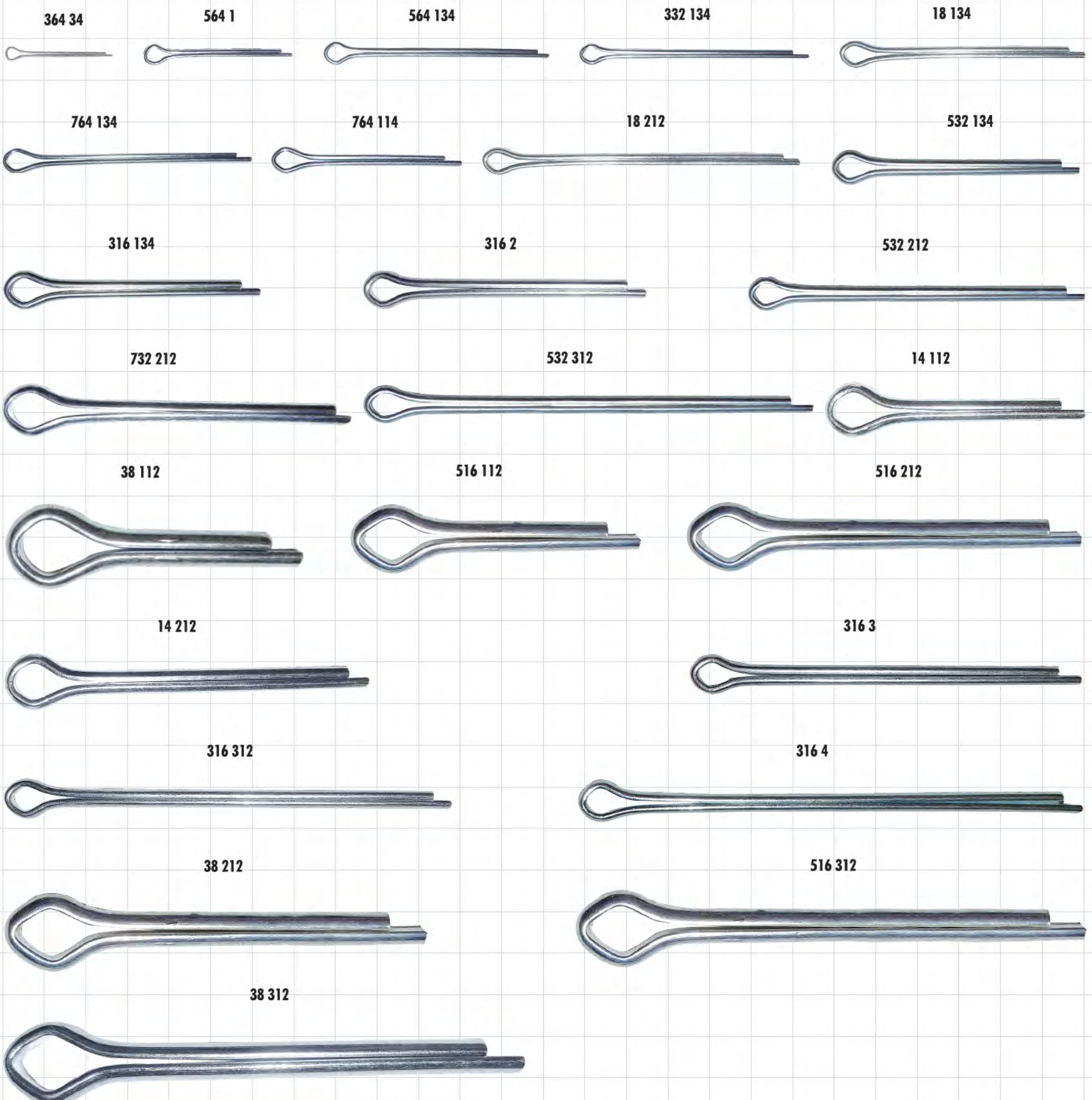

**FAMILIA No. 475 Perno Mecánico de Presión de Acero Fosfatado
DIN 1481**

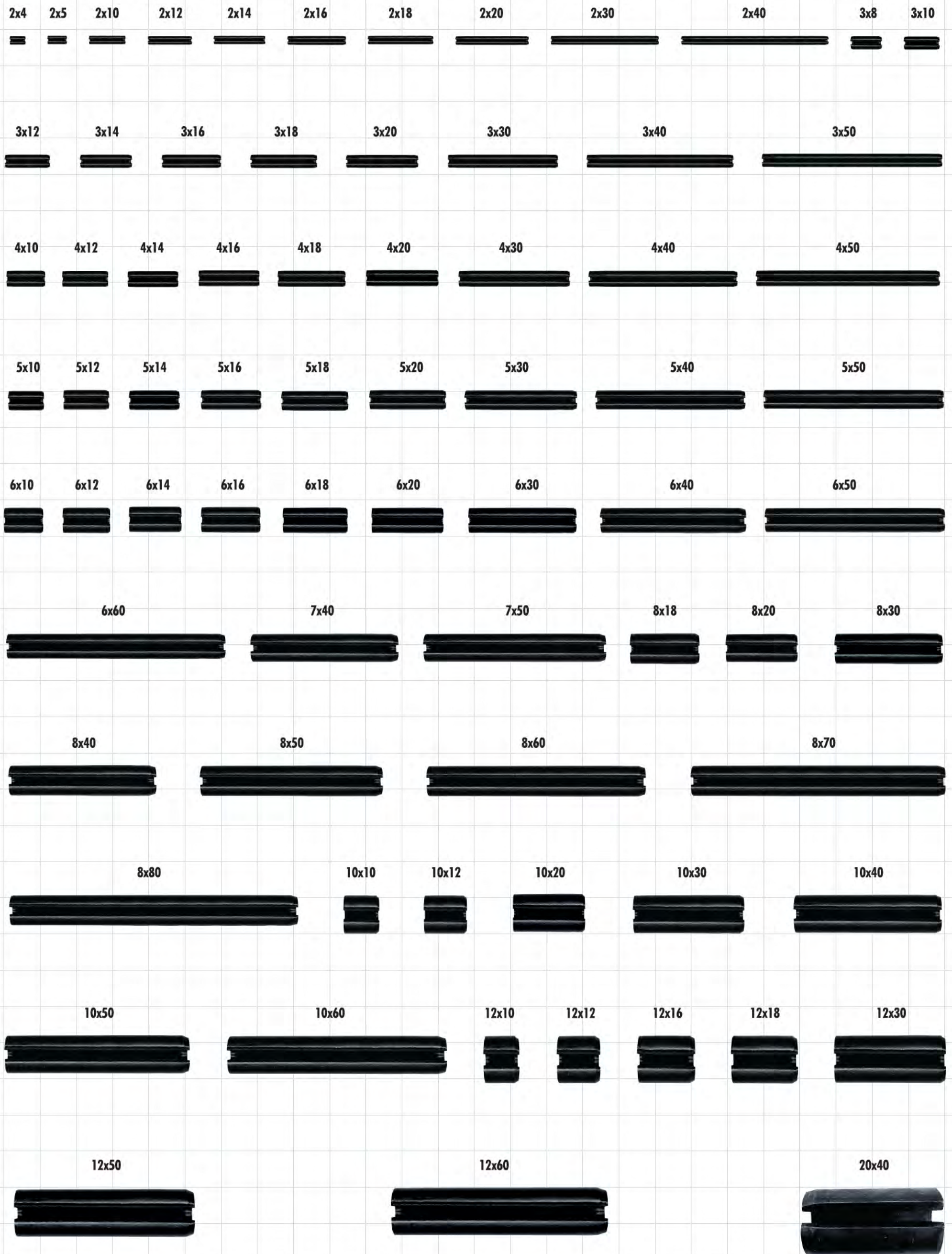

FAMILIA N° 057 Tornillo Hexagonal de Acero Cincado
DIN 933 Clase 8.8 Grado 5

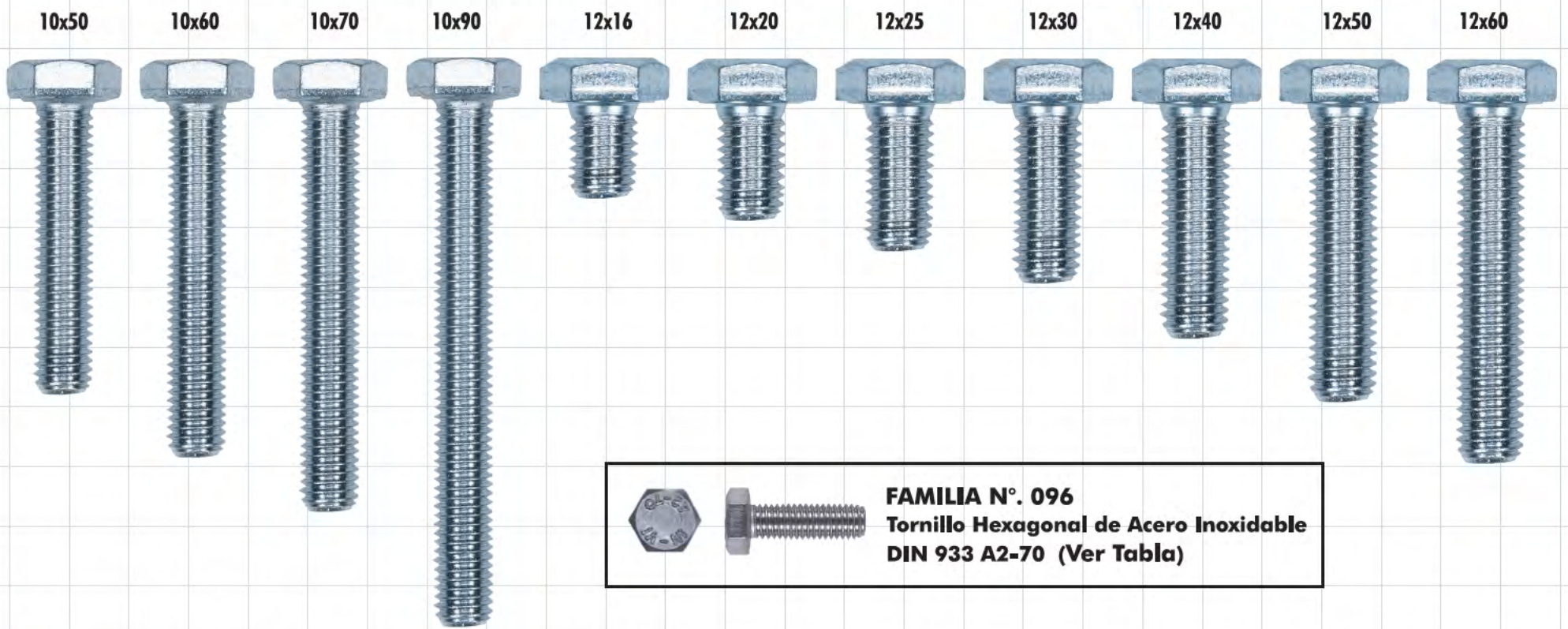

FAMILIA N° 096
Tornillo Hexagonal de Acero Inoxidable
DIN 933 A2-70 (Ver Tabla)

FAMILIA N° 057 0 Tornillo Hexagonal de Acero Bicromatado
DIN 933 Clase 8.8 Grado 5

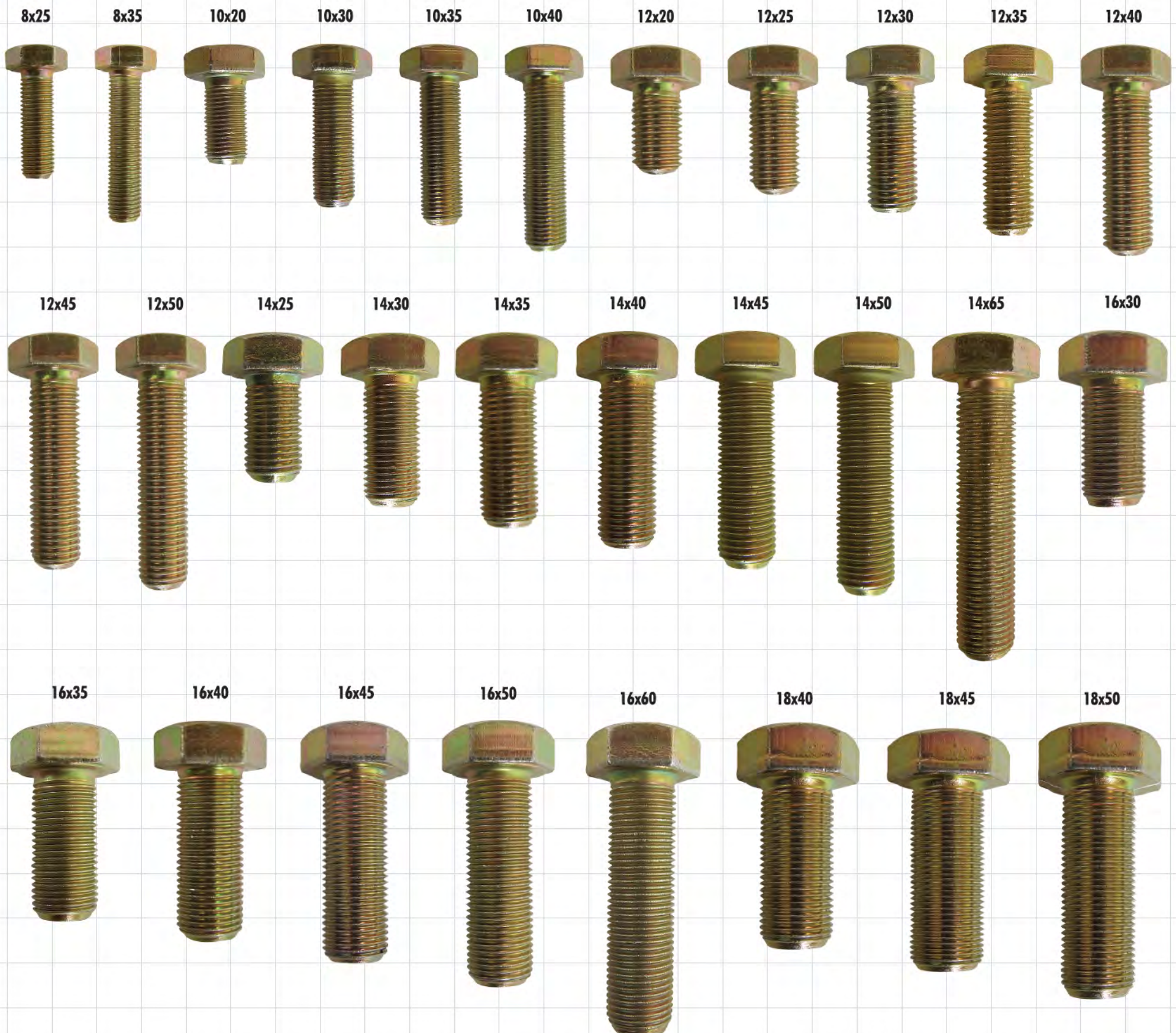

**FAMILIA No. 438 Seguro Exterior Elástico de Acero Fosfatado
DIN 741**

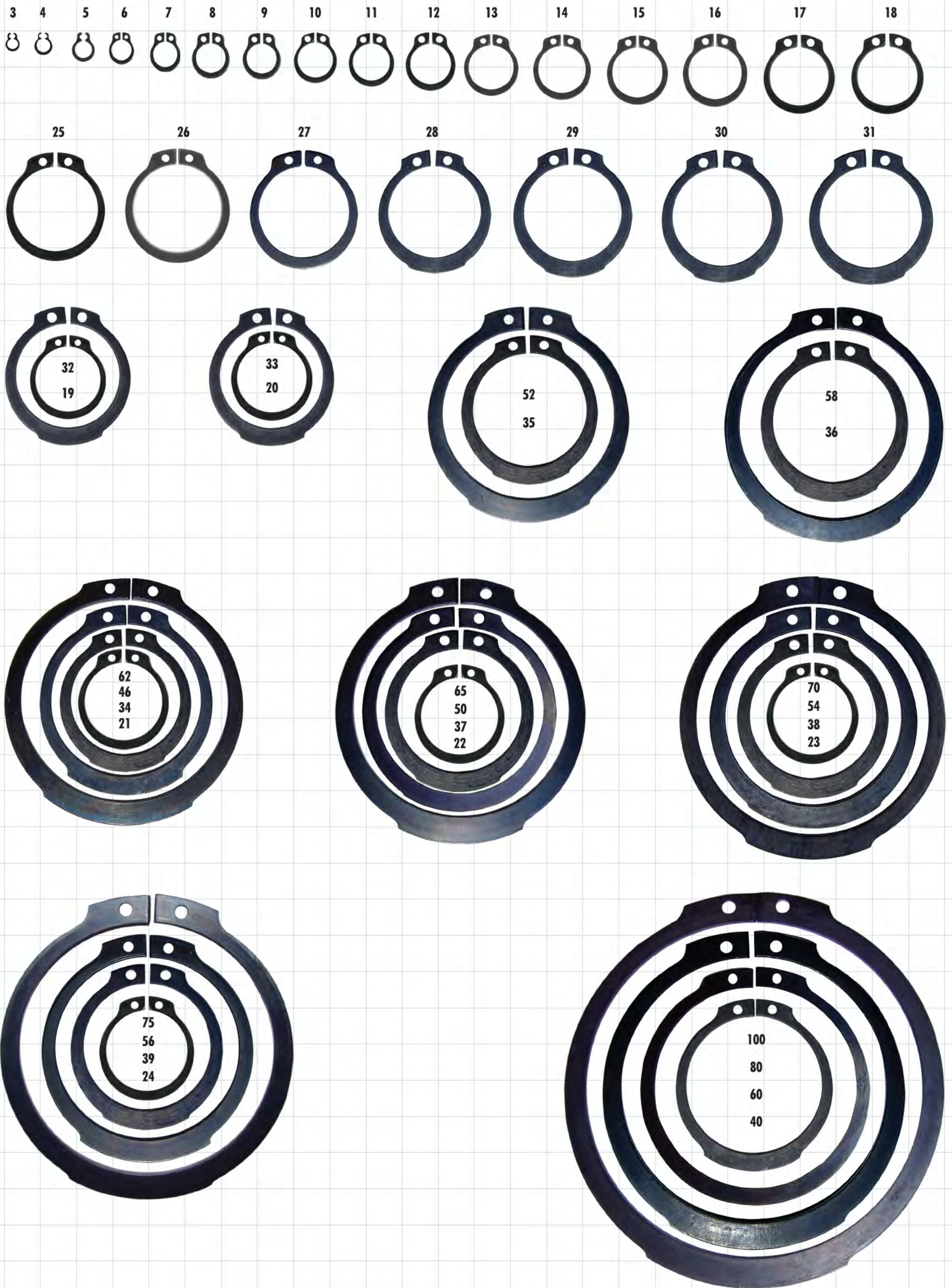

**FAMILIA No. 439 Seguro Interior Elástico de Acero Fosfatado
DIN 472**

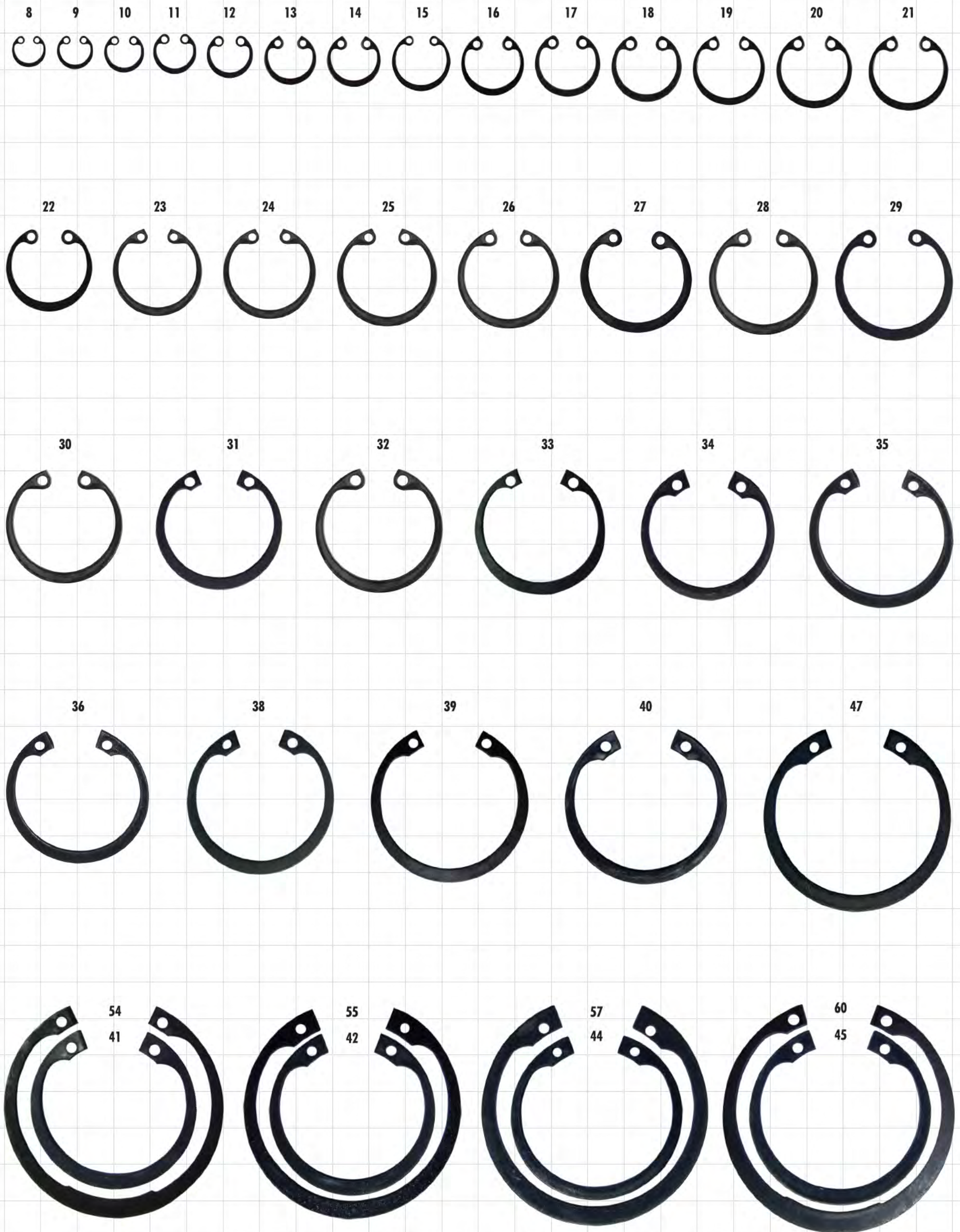

FAMILIA No. 439 Seguro Interior Elástico de Acero Fosfatado DIN 472

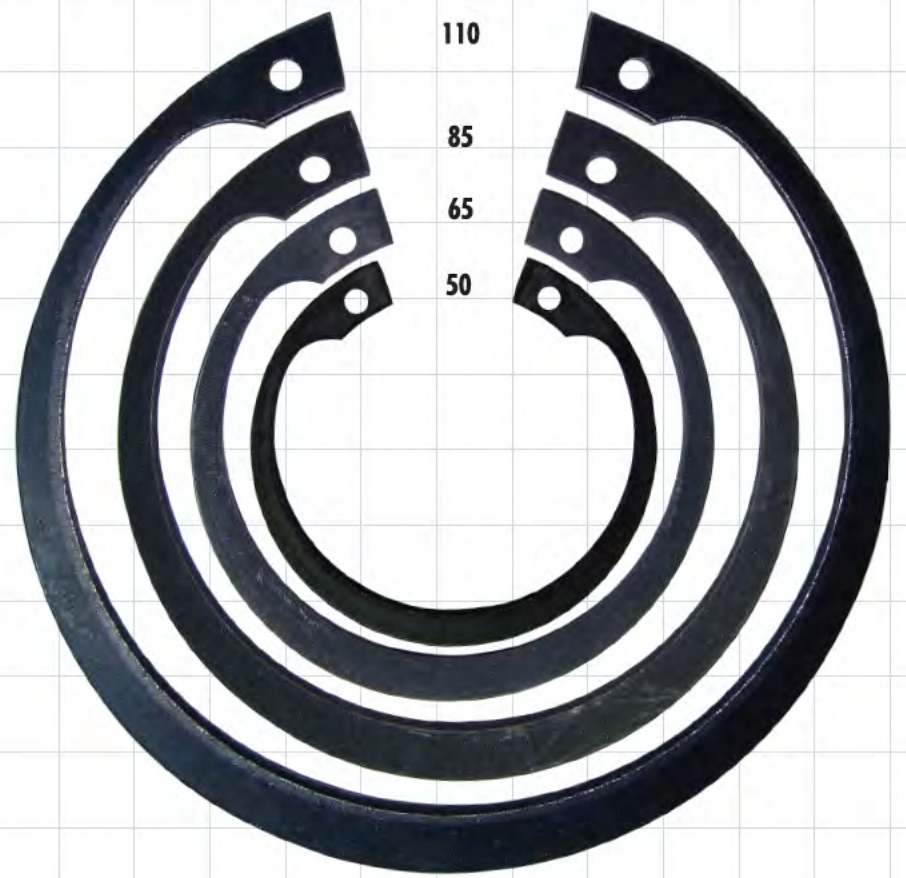
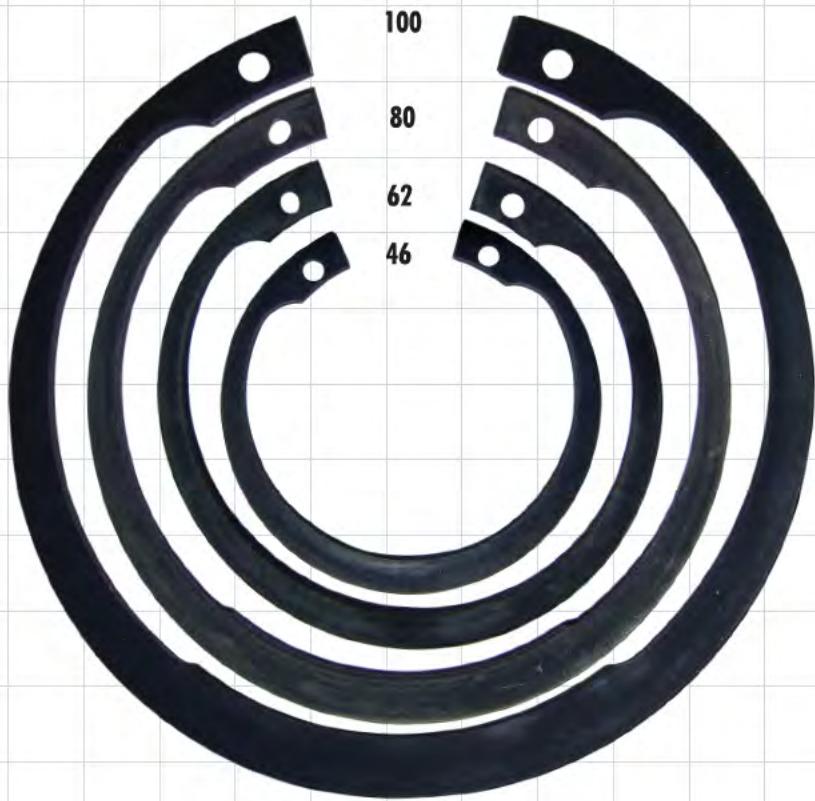
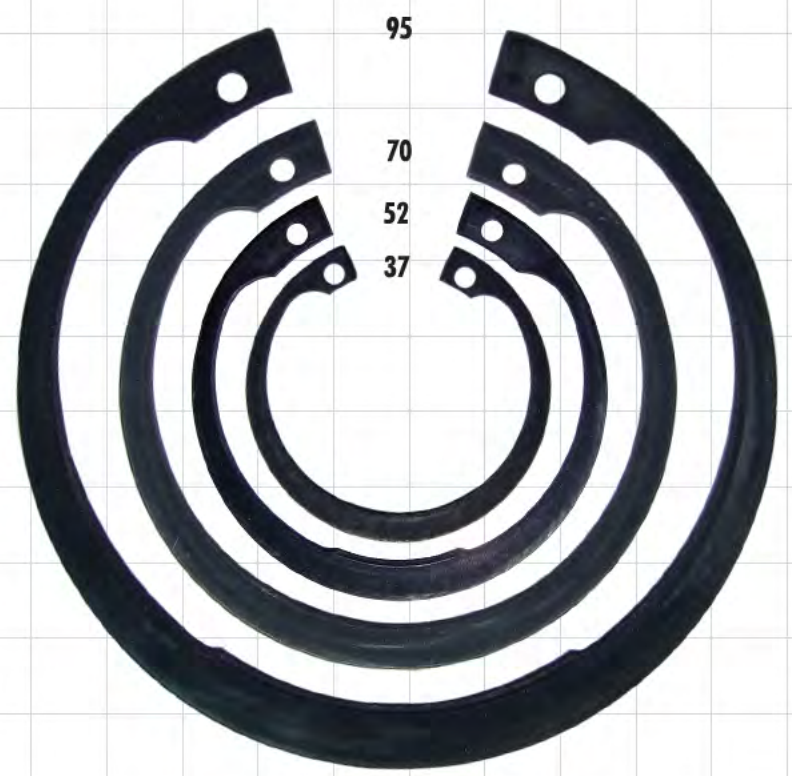

FAMILIA No. 489 Seguro Exterior Acero Inoxidable T-304 DIN 471



**FAMILIA No. 489 Seguro Interior de Acero Inoxidable T-304
DIN 472**

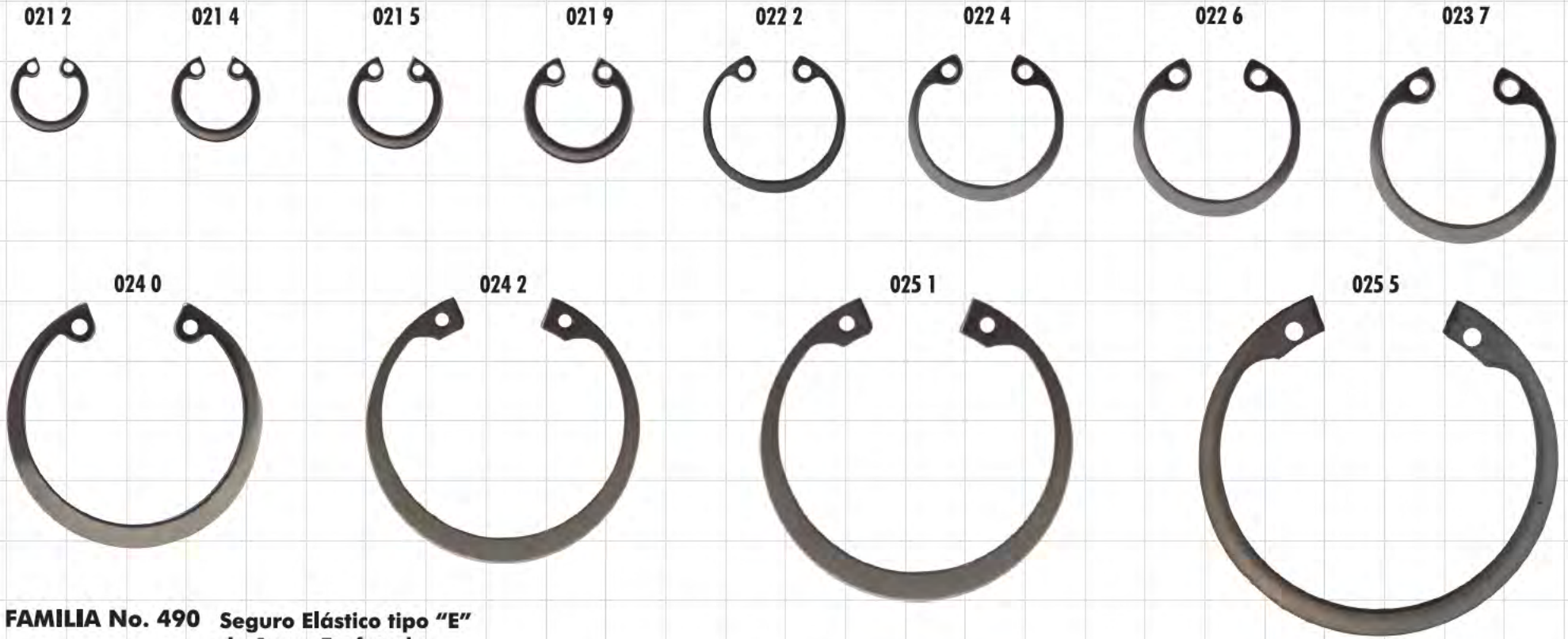

FAMILIA No. 490 Seguro Elástico tipo "E" de Acero Fosfatado

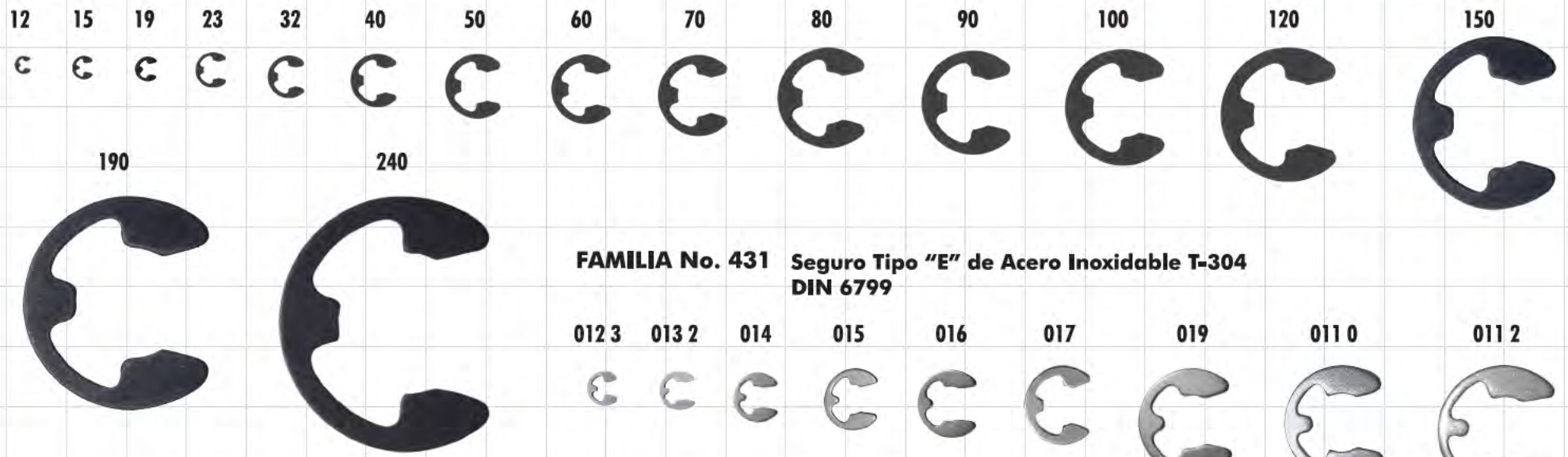

**FAMILIA No. 431 Seguro Tipo "E" de Acero Inoxidable T-304
DIN 6799**



FAMILIA No. 438 Seguro de Presión para Flecha de Acero Fosfatado



FAMILIA No. 491 Seguro para Eje Desmontable de Acero Fosfatado



FAMILIA No. 492 (KL)



FAMILIA No. 473 Seguro Tipo "R" de Acero Cincado

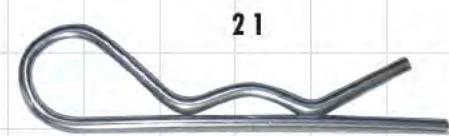

FAMILIA No. 472 Seguro Agrícola de Acero Bicromatado

45 8



**FAMILIA No. 460 Junta Plana de Cobre
DIN 7603**

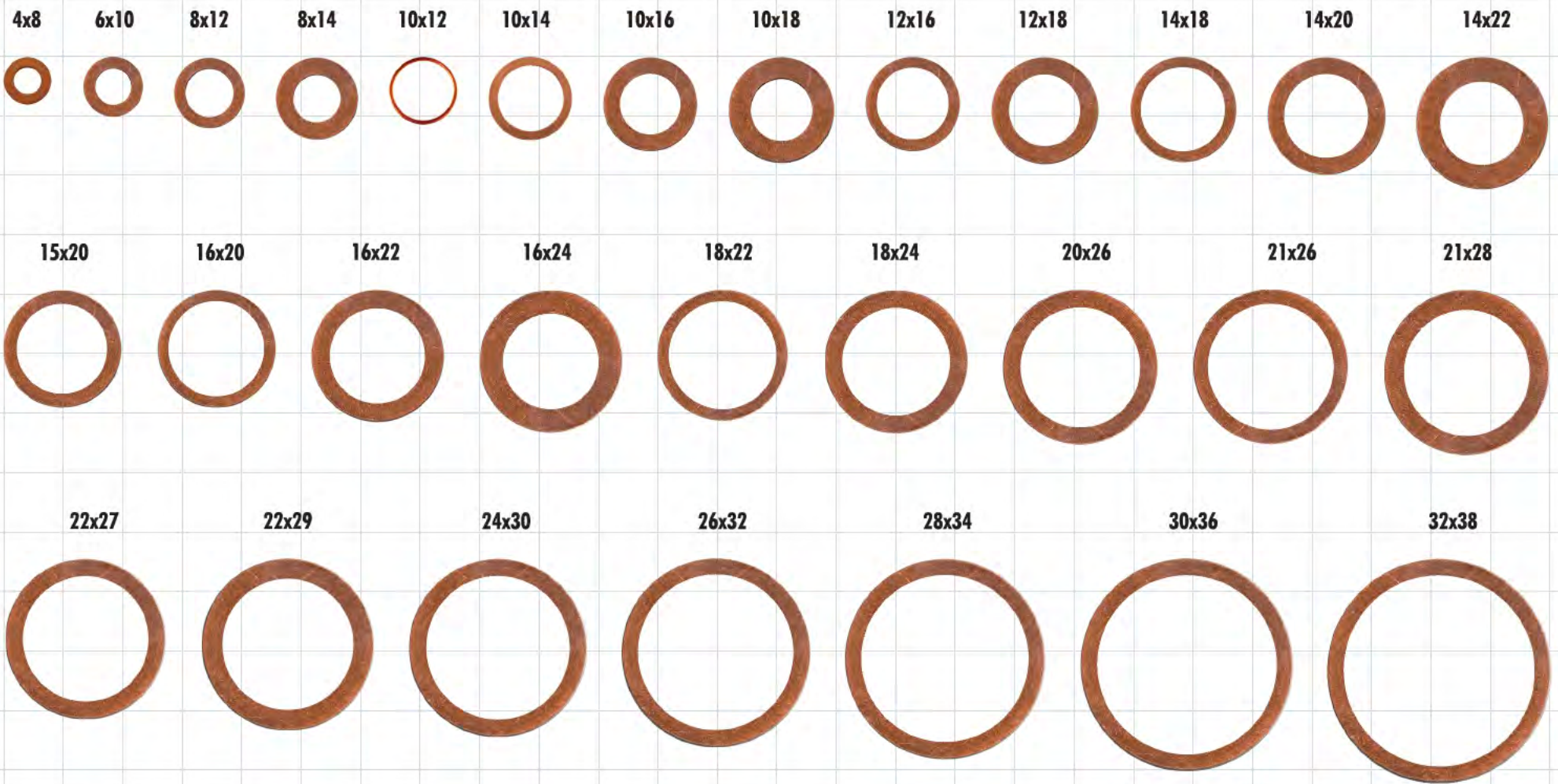

**FAMILIA No. 462 Junta de Cobre Rellena de Amianto Alto Sellado
(900 °C) DIN 7603 C**



**FAMILIA No. 463 Junta Plana de Aluminio
DIN 7603**

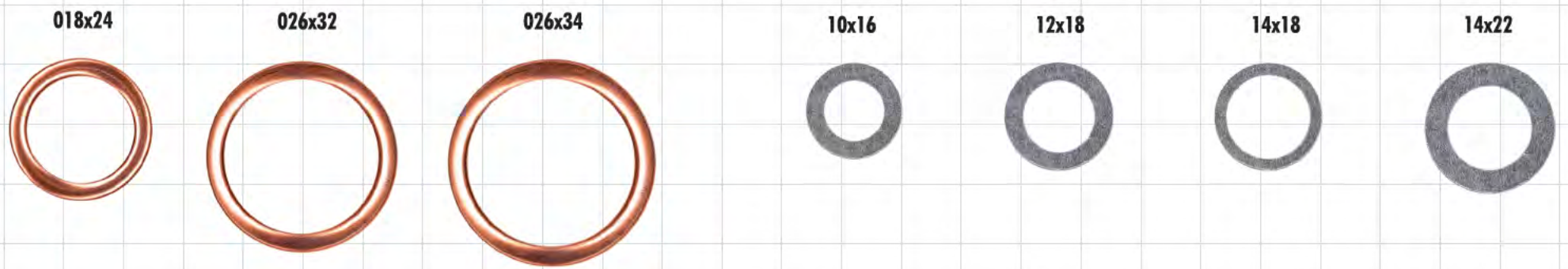

FAMILIA No. 465 Junta de Fibra Vulcanizada, Temperatura de Trabajo 30 °C DIN 7603

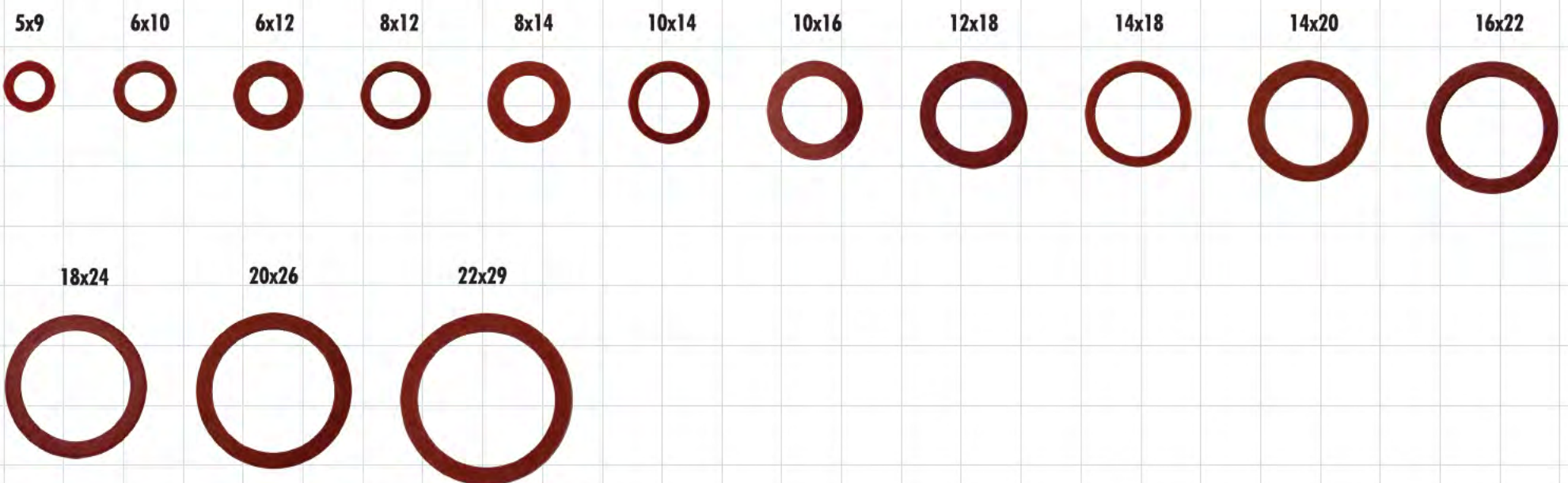

FAMILIA No. 468 O' Ring de Caucho Nitrilico en Pulgadas

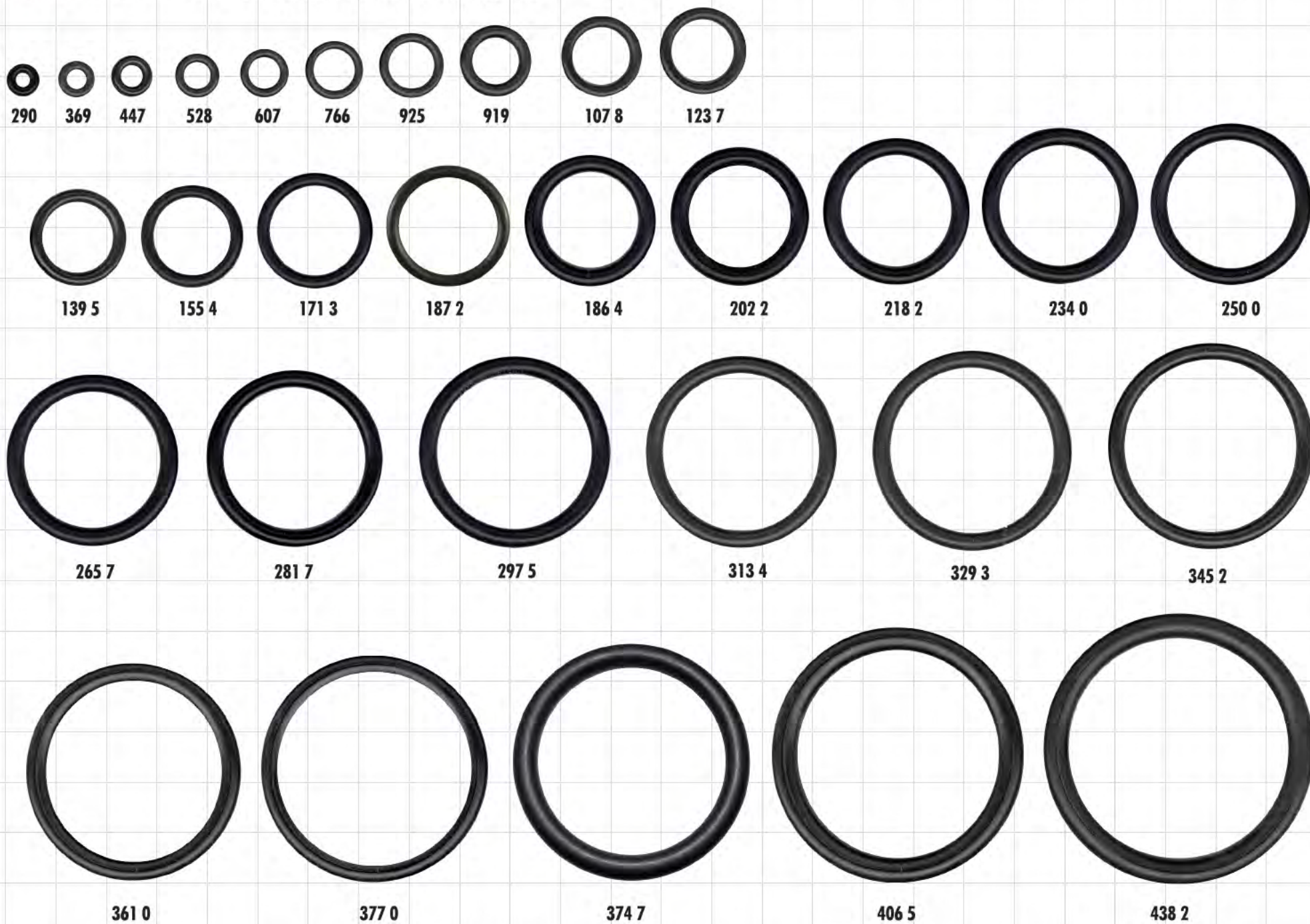

Milimétricos

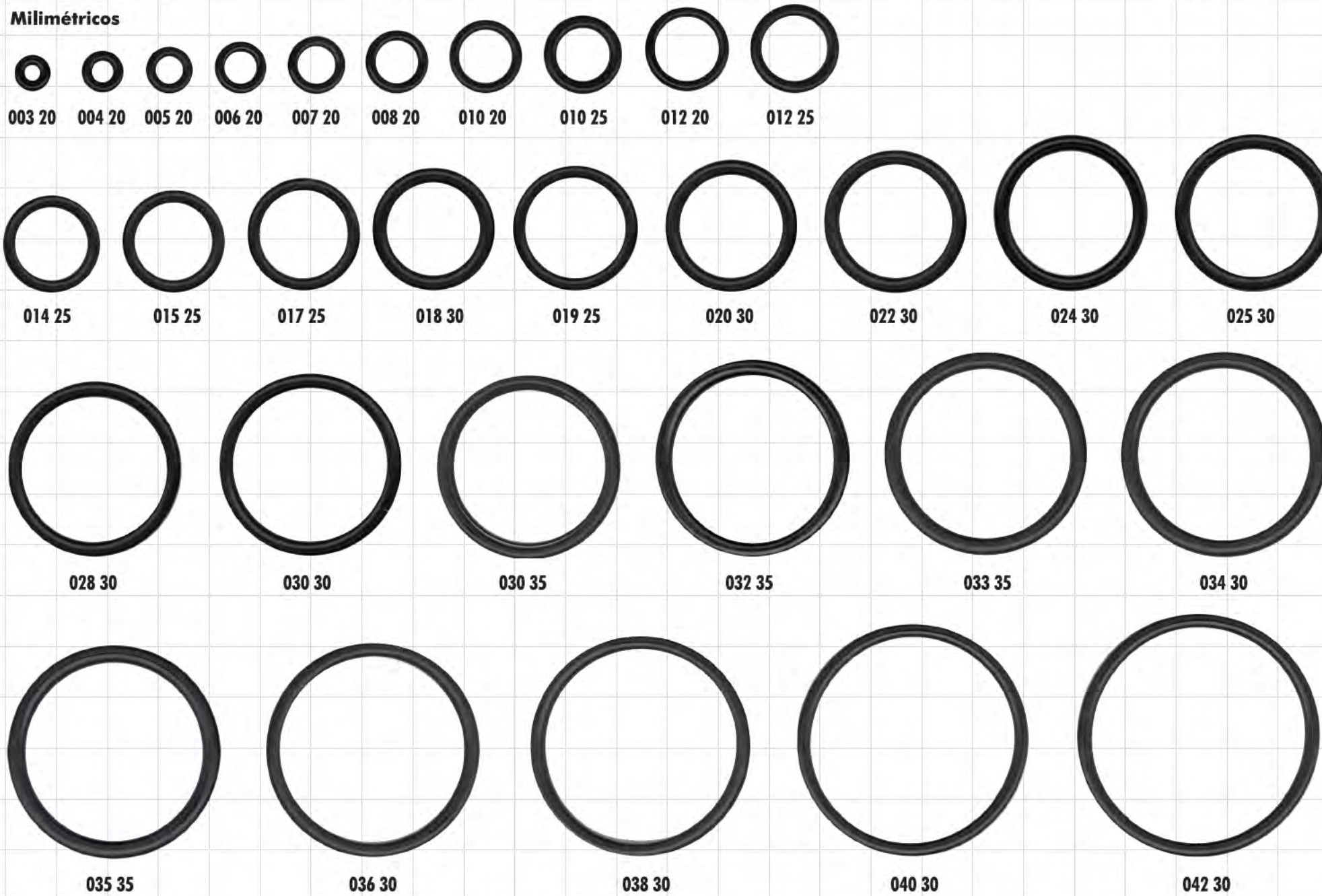

FAMILIA No. 468 O'Ring de Caucho Nitrilico Milimétrico

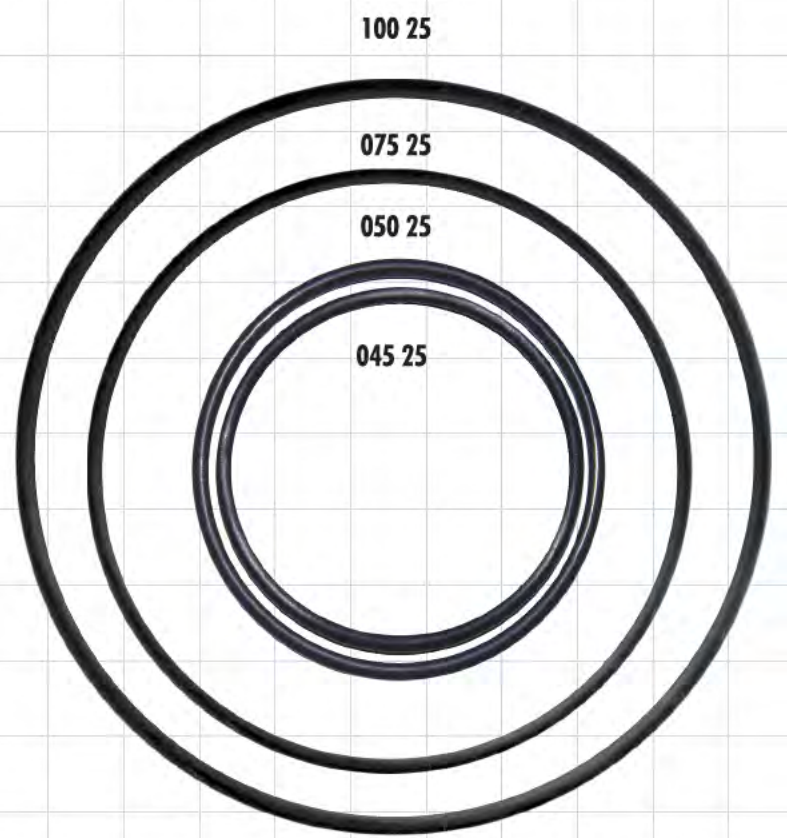
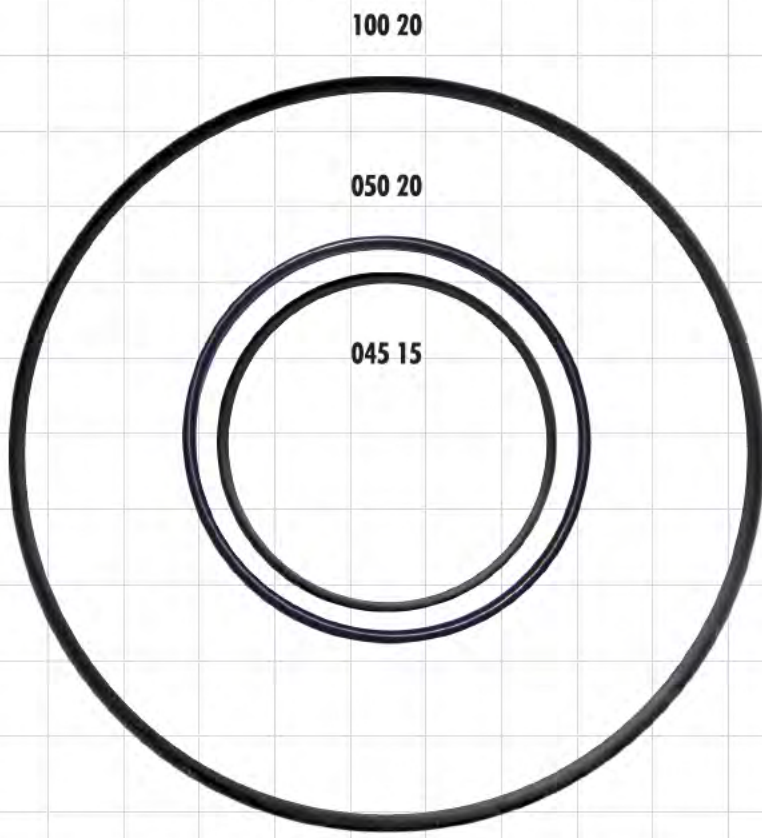

FAMILIA No. 468 Tramo para fábrica de O'Ring (1 Mt.)



FAMILIA No. 469 O'Ring para Aire Acondicionado Universal (Perbunan) -35°C a 150°C

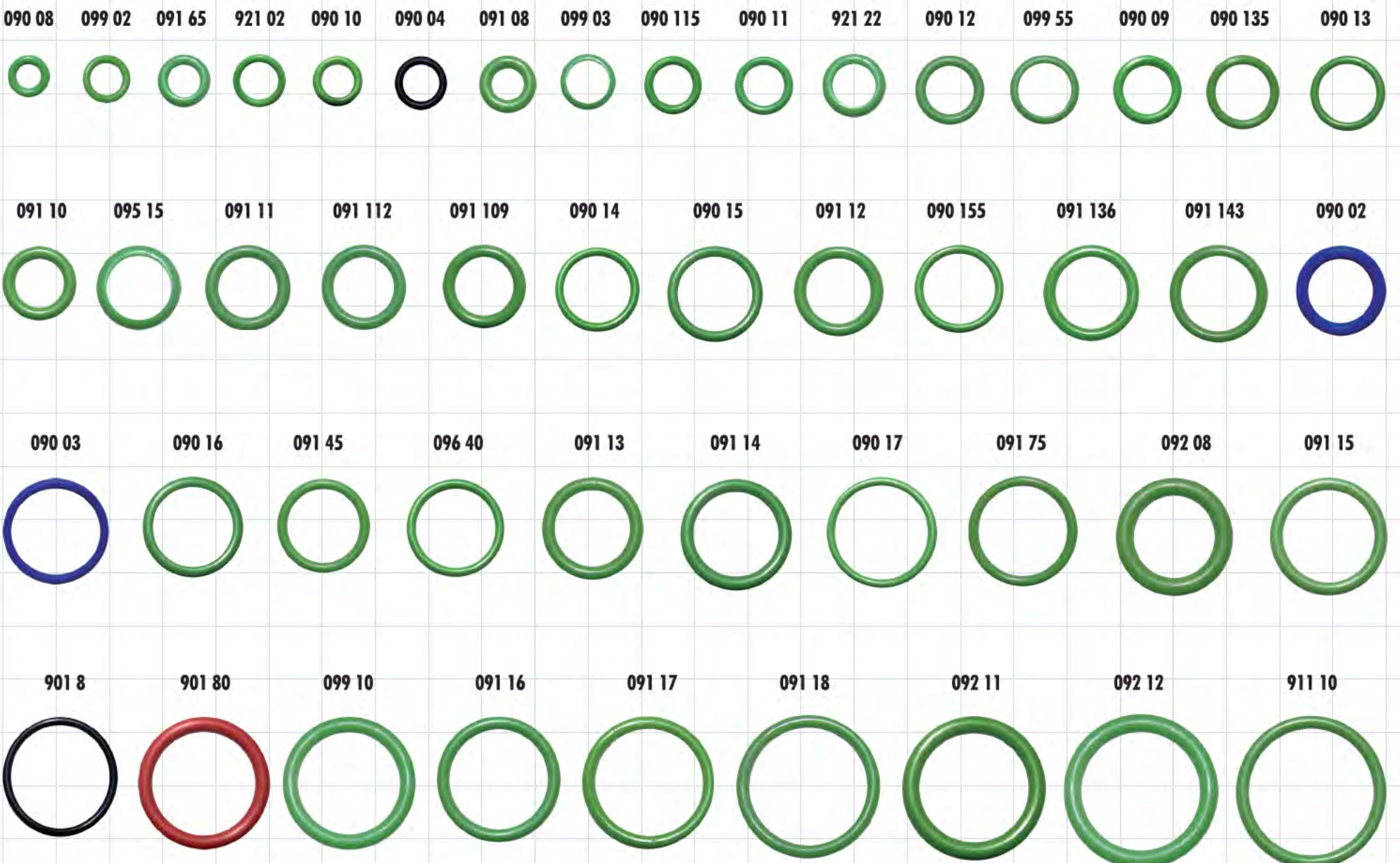

FAMILIA No. 500 Grapas



FAMILIA No. 500 Grapas

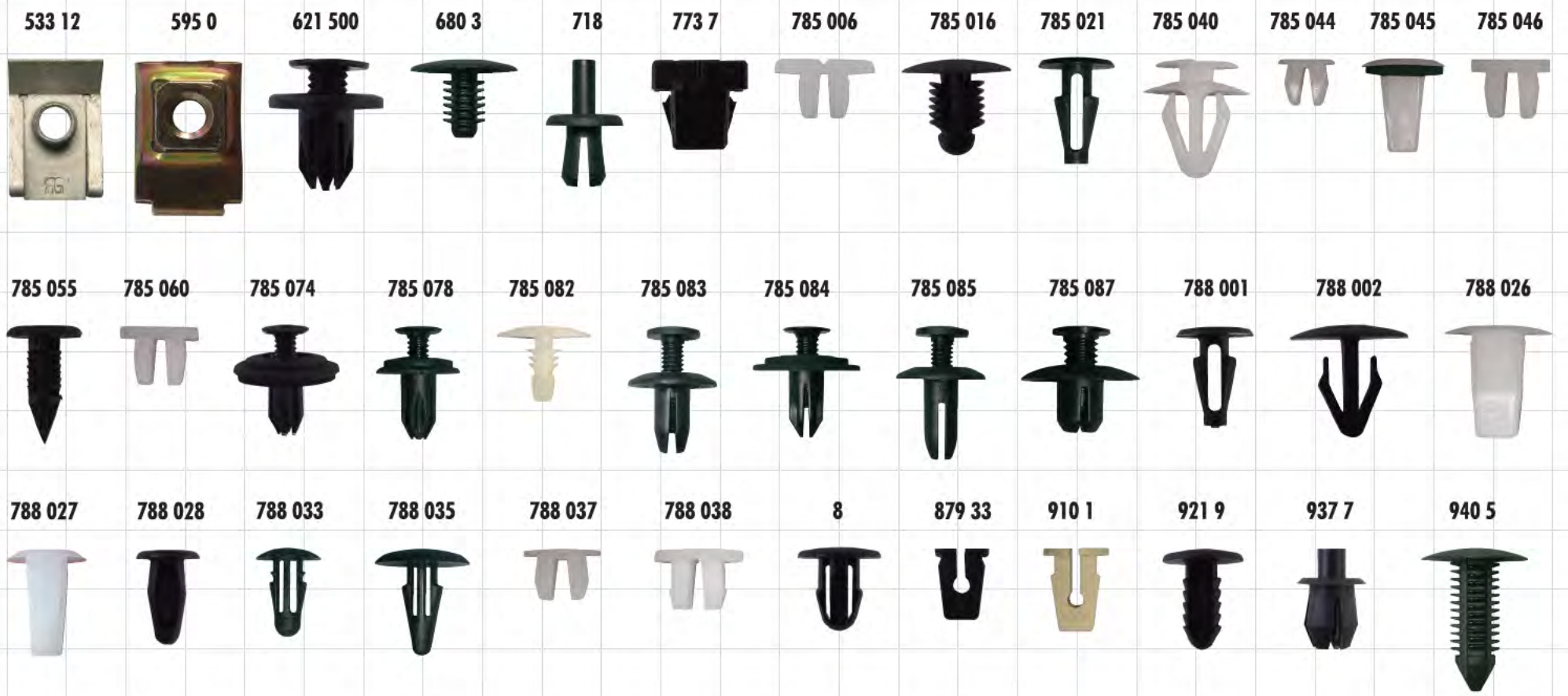

GRUPO No. 501 Grapas

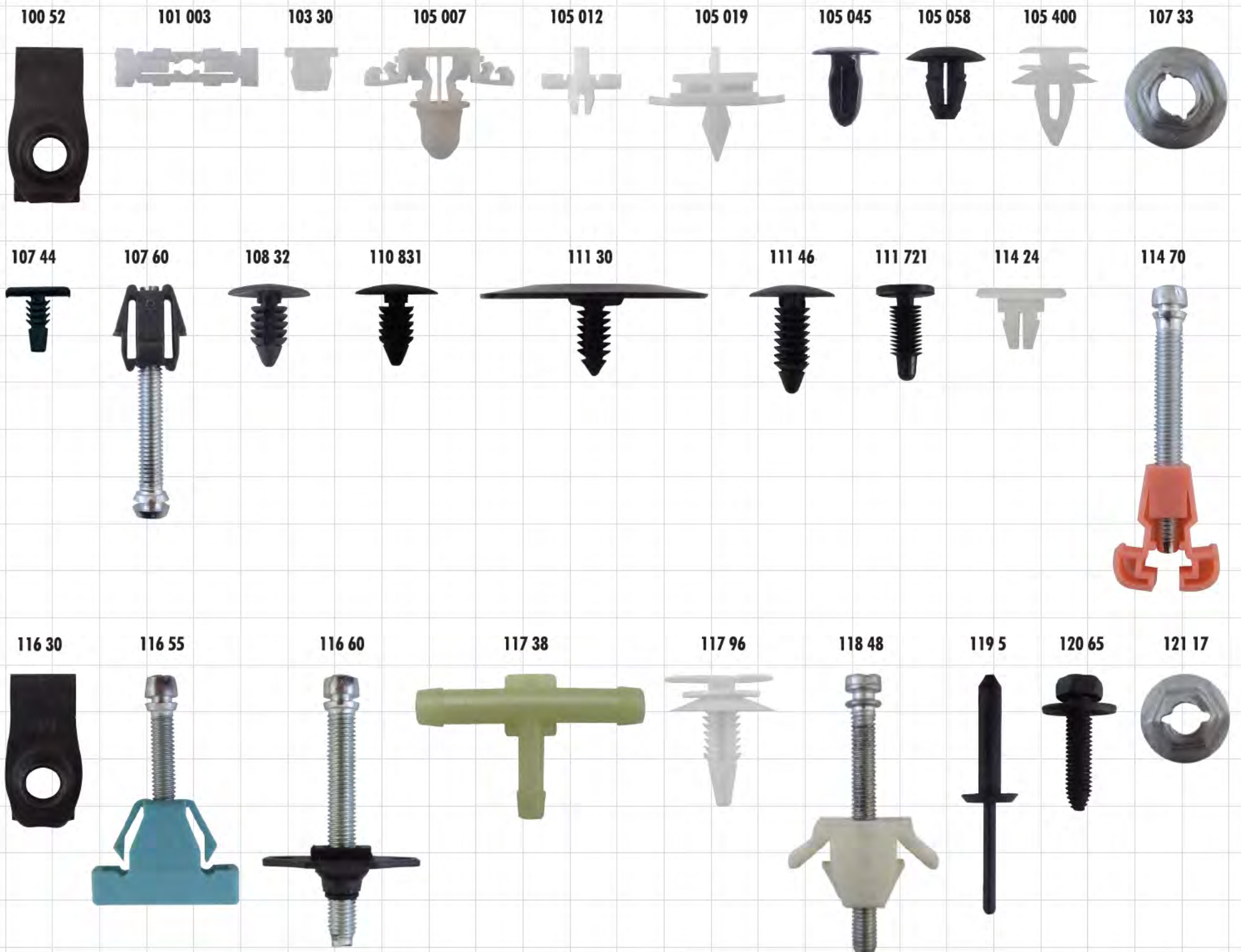

FAMILIA N° 281 Tornillo Cónico (Phillips) de Acero Inoxidable
DIN 965

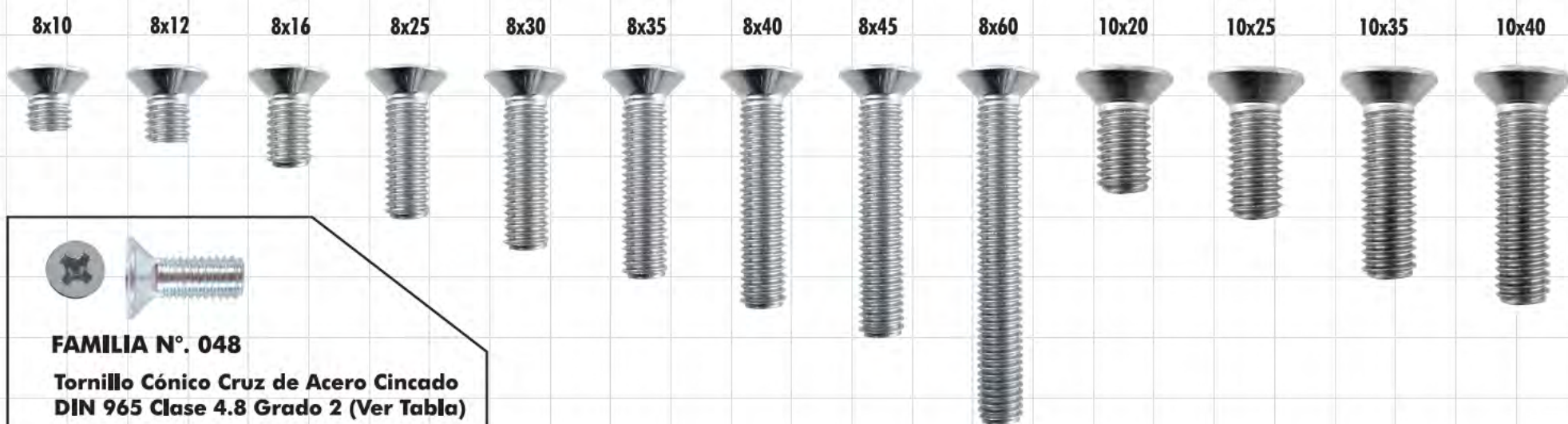
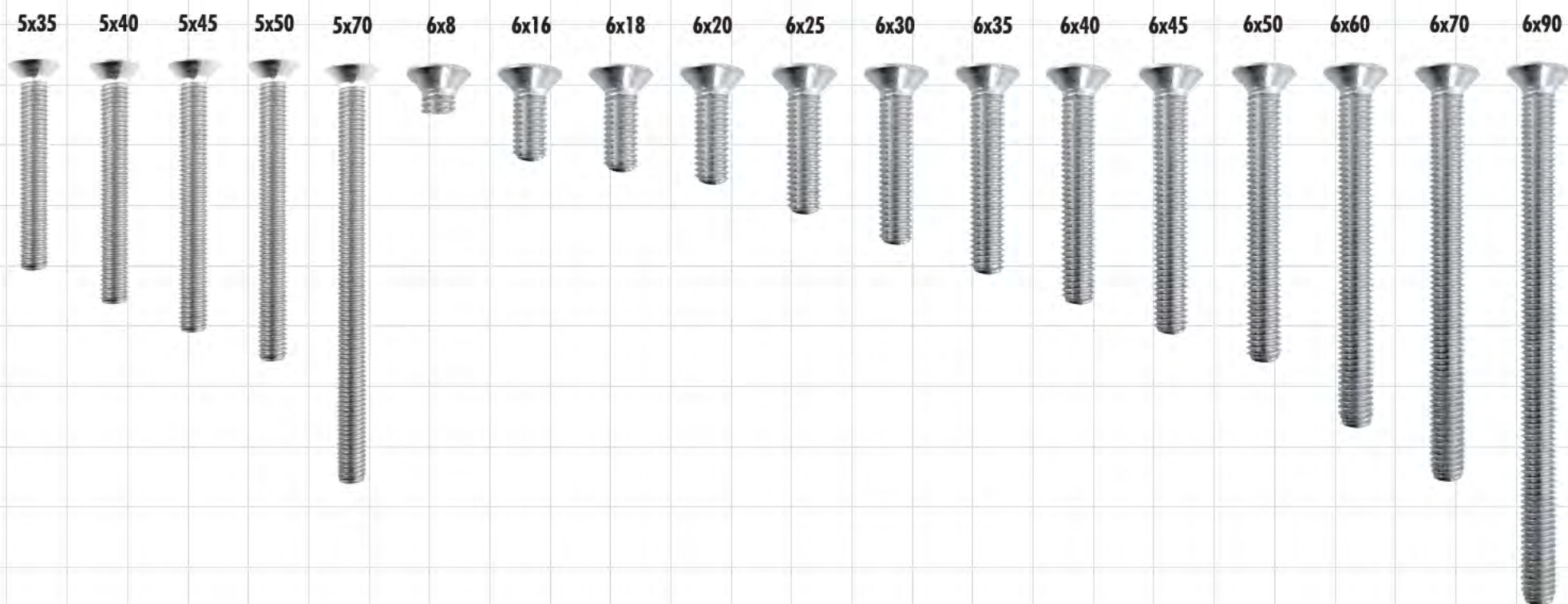
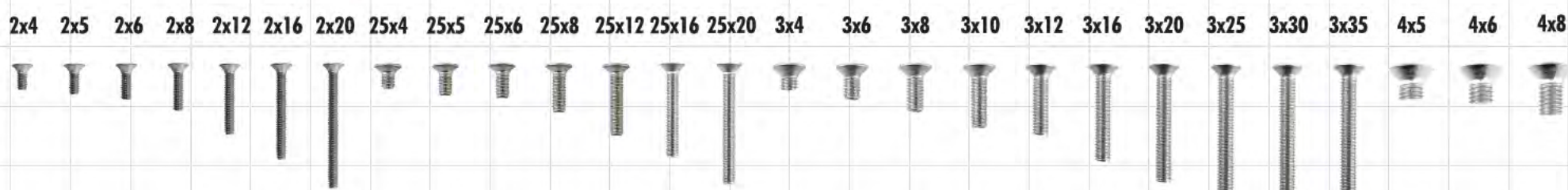

FAMILIA N° 048
Tornillo Cónico Cruz de Acero Cincado
DIN 965 Clase 4.8 Grado 2 (Ver Tabla)

FAMILIA N° 089
Tornillo Cónico Allen de Acero Fosfatado
DIN 7991 Clase 10.9 Grado 8 (Ver Tabla)

FAMILIA N° 100
Tornillo Cónico Allen de Acero Inoxidable
T. 304 DIN 7991 (Ver Tabla)

FAMILIA N° 282
Tornillo Cónico Cruz Cabeza de Gota
de Acero Cincado DIN 966 (Ver Tabla)

GRUPO No. 501 Grapas

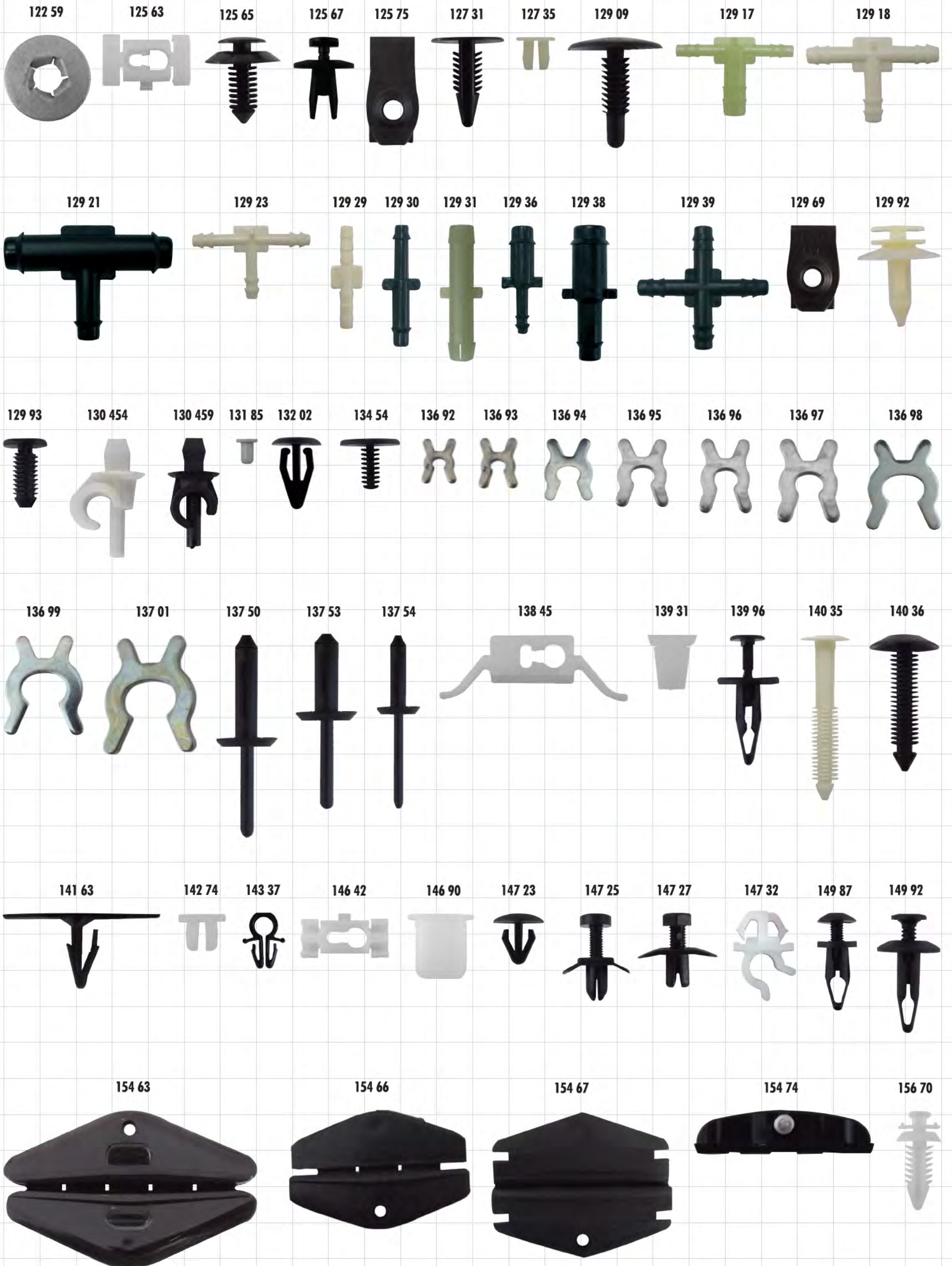

GRUPO No. 501 Grapas Varias



GRUPO No. 501 Grapas

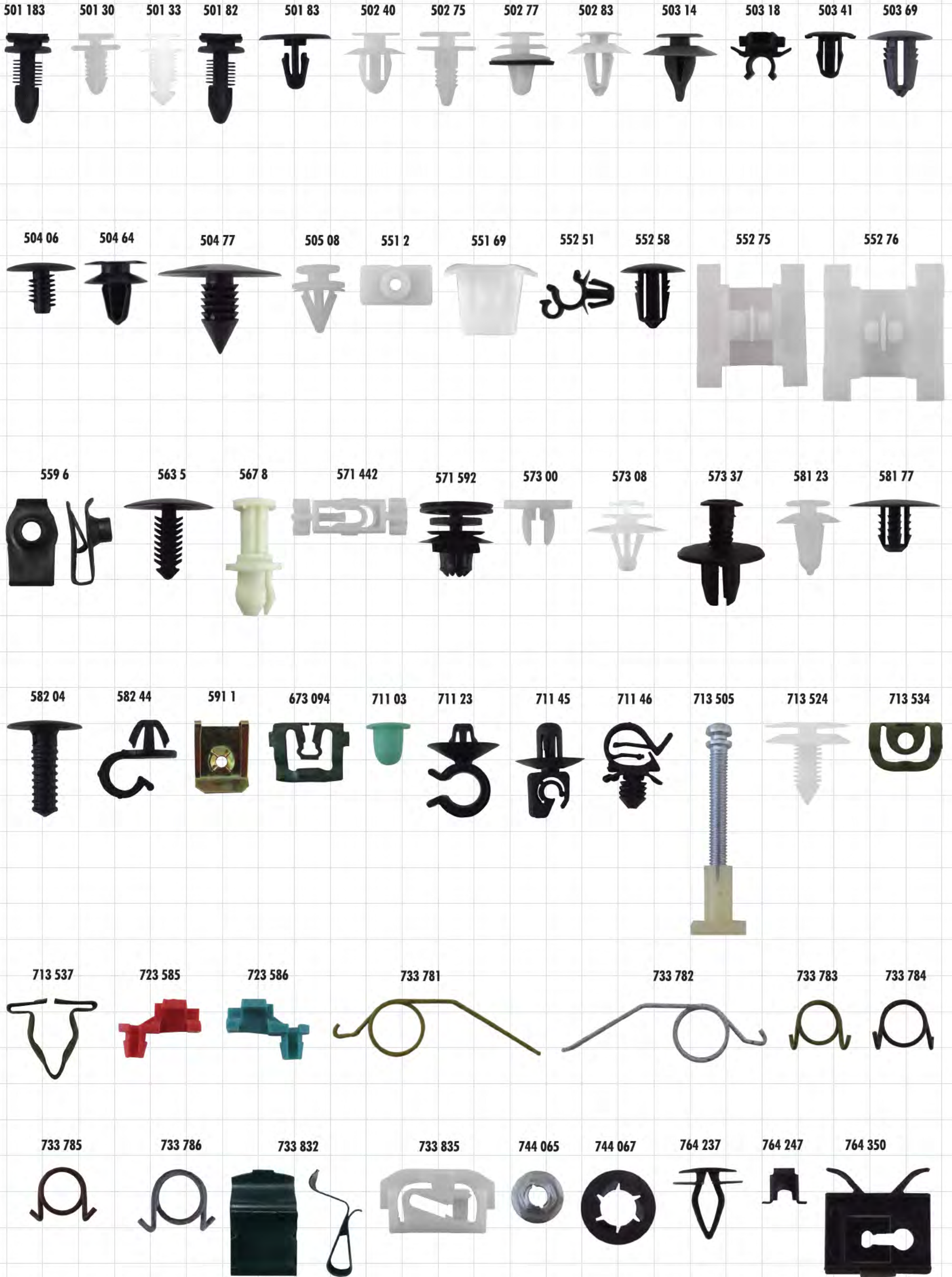

GRUPO No. 501 Grapas



GRUPO No. 501 Grapas

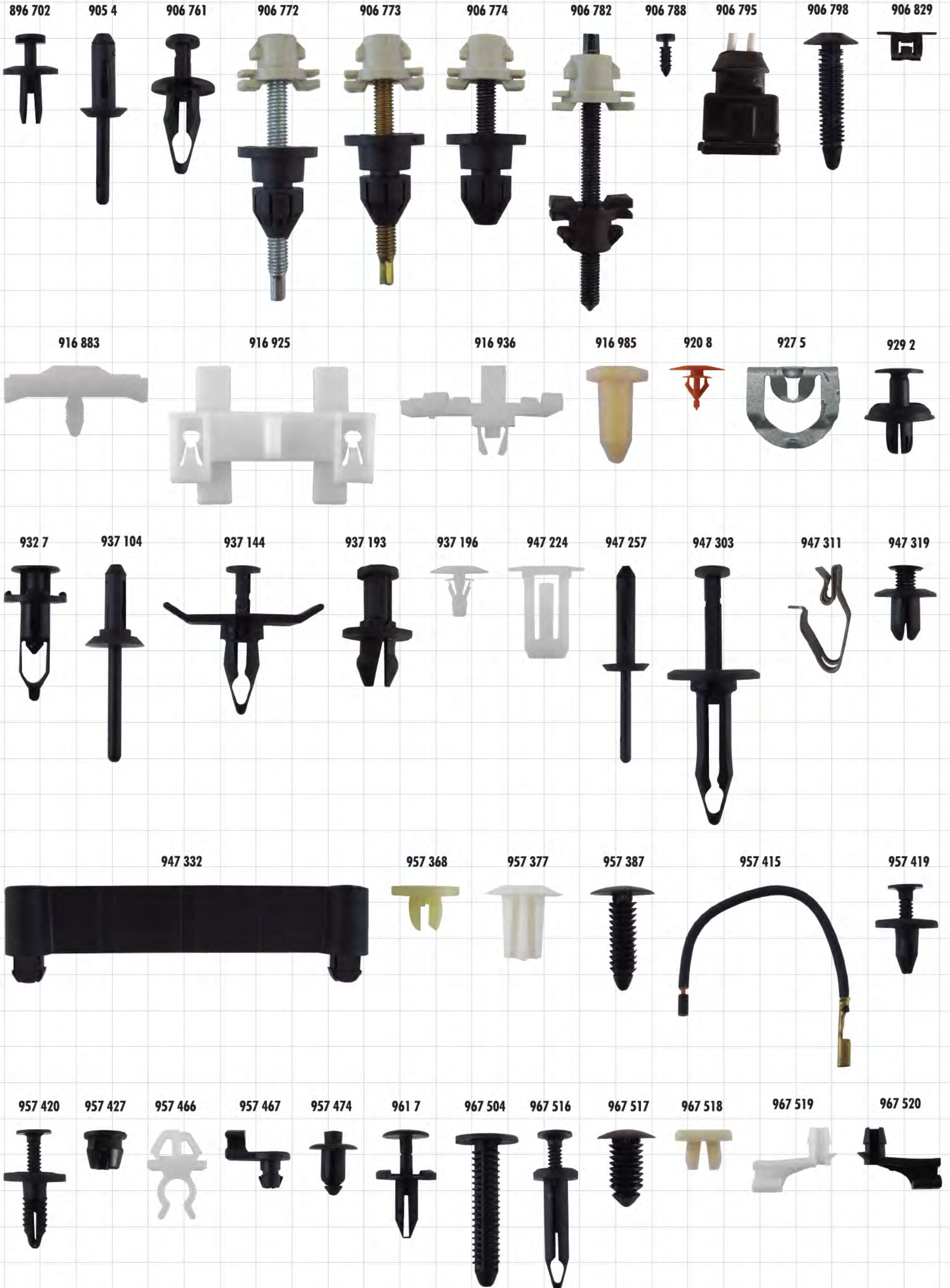

GRUPO No. 501 Grapas

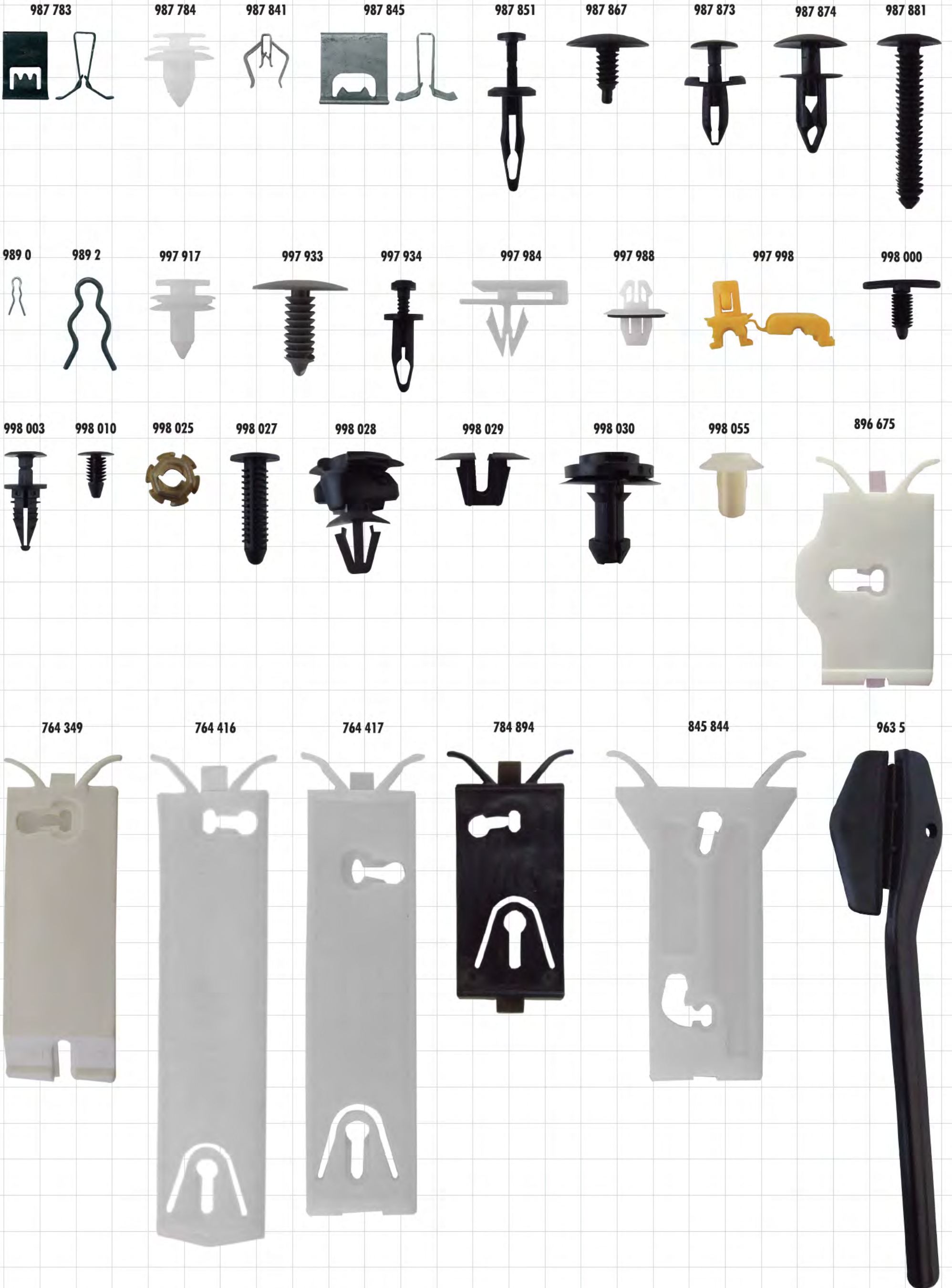

FAMILIA No. 506 Muelles DIN 2095 y Resortes DIN 2097 de Acero Galvanizado Cincado

08 42



10 32



10 321



10 35



10 40



10 60



10 65



15 28



15 35



15 45



15 451



15 55



15 551



15 552



15 553



15 65



206 25



206 50



206 55



210 45



210 55



210 551



210 60



210 70



210 701



210 75



210 85



210x90



210 100



210 105



210 130



213 25



213 55



215 65



215 75



215 110





FAMILIA No. 547
Abrazadera Americana
Ancho de Fleje 1/2 "



700 4

7/32-5/8



700 6

7/16-25/32



700 8

1/2-25/32



701 0

9/16- 1 1/16



701 2

11/16-1 1/4



701 6

13/16 - 1 1/2

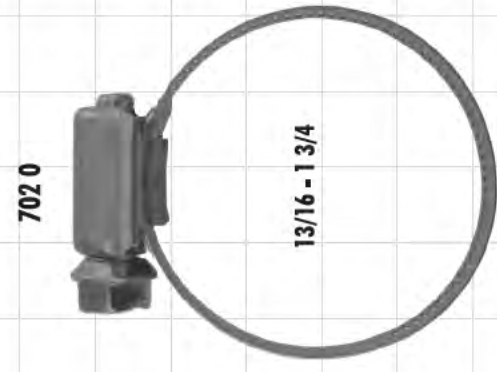

702 0

13/16 - 1 3/4

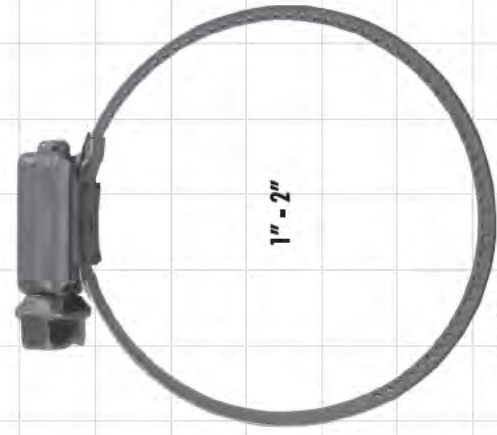

702 4

1" - 2"

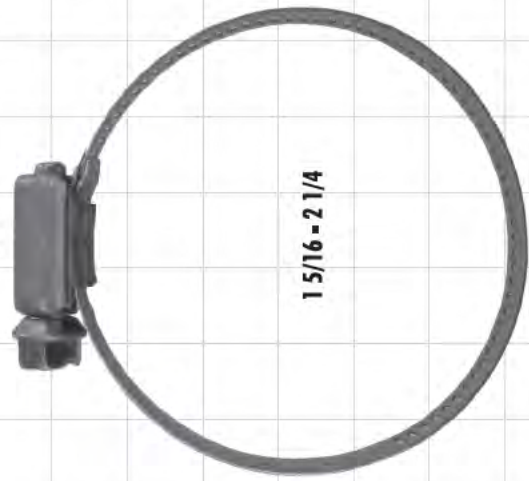

702 8

1 5/16 - 2 1/4

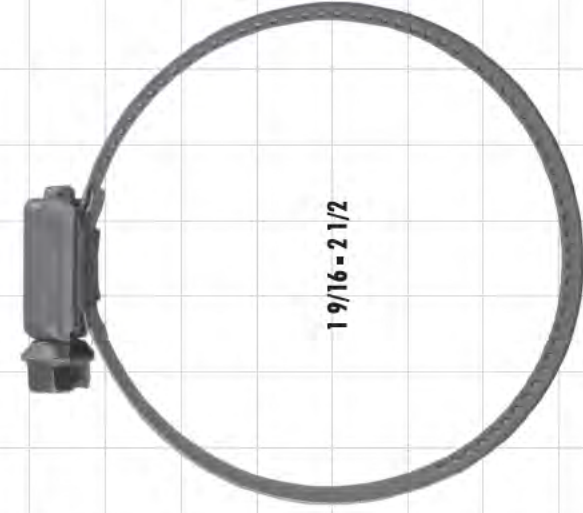

703 2

1 9/16 - 2 1/2

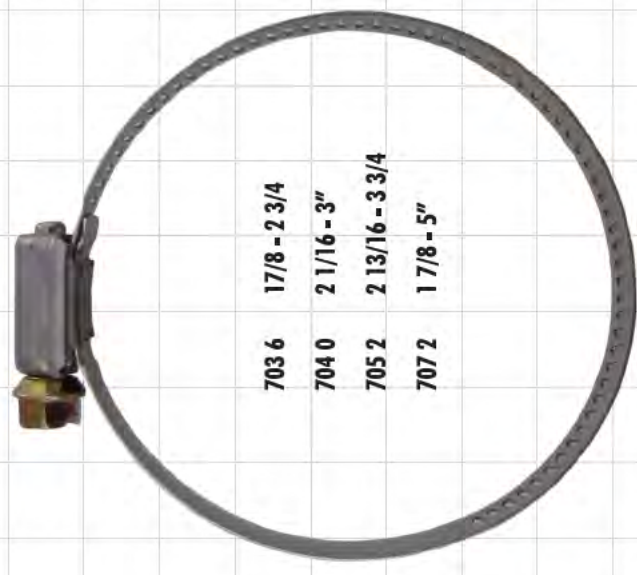

703 6

703 6 17/8 - 2 3/4
704 0 2 1/16 - 3"
705 2 2 13/16 - 3 3/4
707 2 1 7/8 - 5"



FAMILIA No. 539
Abrazadera Zebra
Fleje sn Ranurar
de 9mm



8 12

5/16 - 1/2



10 16

3/16 - 5/8



12 20

1/2 - 3/4



16 25

5/8 - 1

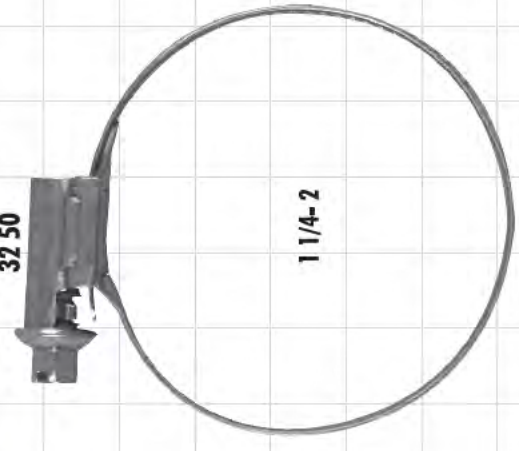

32 50

1 1/4 - 2



25 40

1 - 1 5/8



20 32

3/4 - 1 1/4

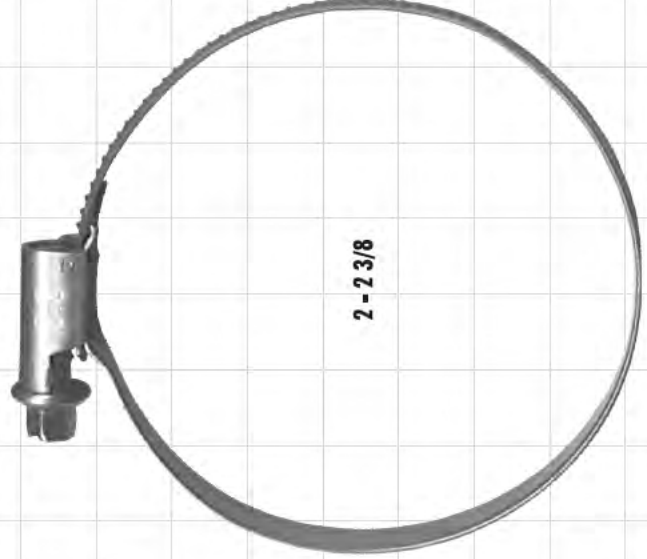

50 70

2 - 2 3/8

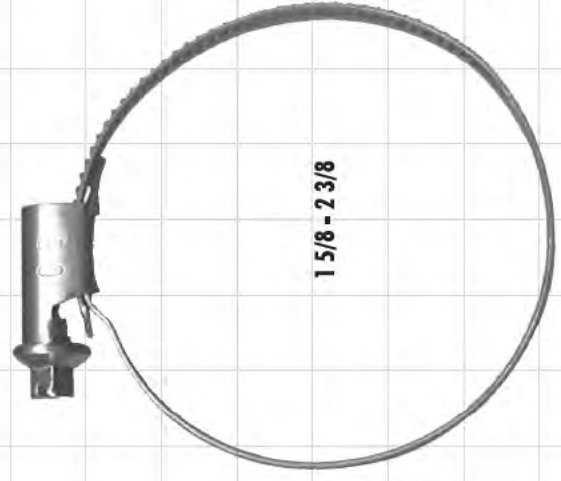

40 60

1 5/8 - 2 3/8

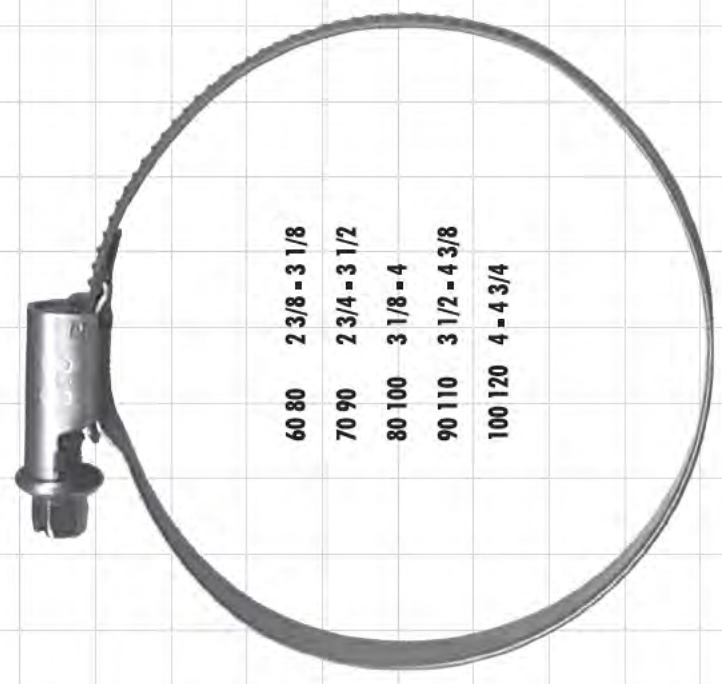

60 80

60 80 2 3/8 - 3 1/8
70 90 2 3/4 - 3 1/2
80 100 3 1/8 - 4
90 110 3 1/2 - 4 3/8
100 120 4 - 4 3/4



LIA No. 549 Abrazadera Zebra Ancha
13 mm

240 60



15/8 - 2 3/8

225 40



1 - 1 5/8

250 70

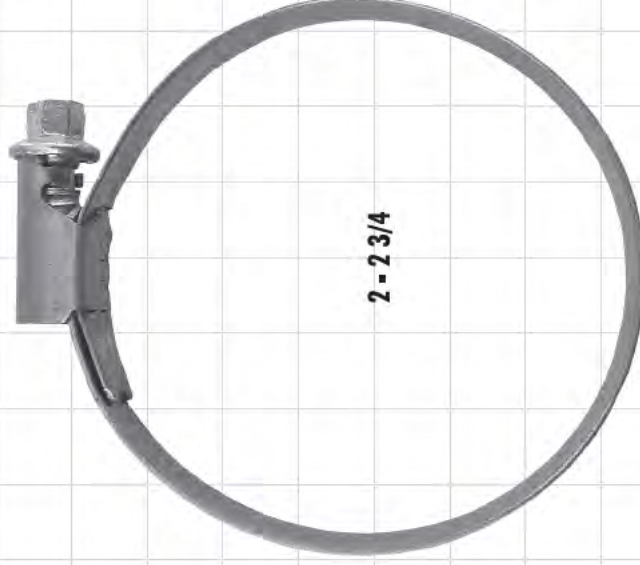

2 - 2 3/4

60 80

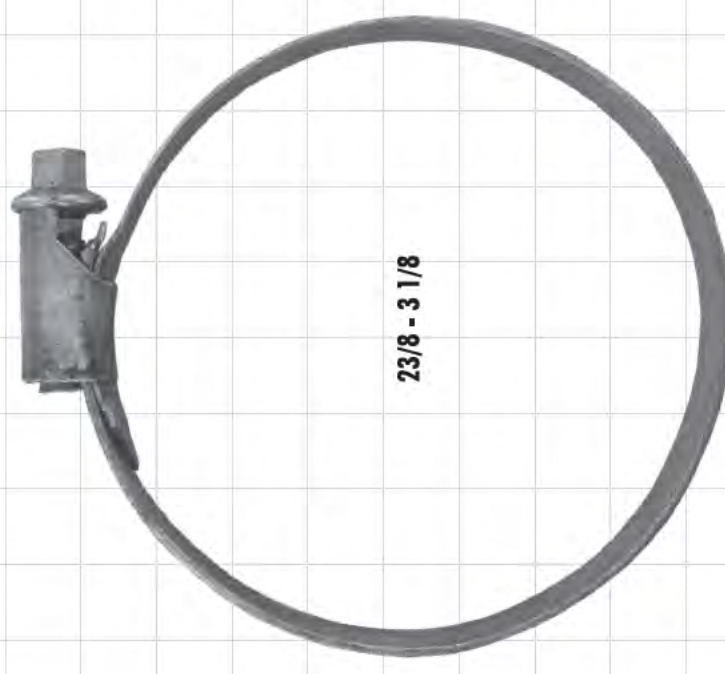

23/8 - 3 1/8

FAMILIA No. 540 Abrazaderas de Acero Cincado
de Doble Fleje con Tornillo para Alta Presión

011 13



013 15



014 16



159



169



179



189



199



209



219



229



239



249



259



269



289



309



123



145



FAMILIA No. 541 Abrazaderas Anillo de Acero
Inoxidable de Presión

FAMILIA No. 537 Abrazadera de Acero Bicromatado para Alta Presión

26 28



29 31



32 35



36 39

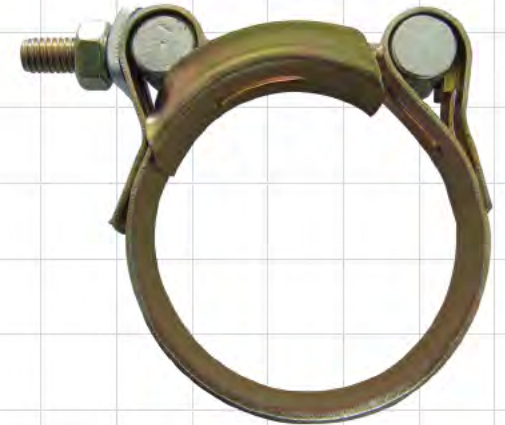

40 43



44 47

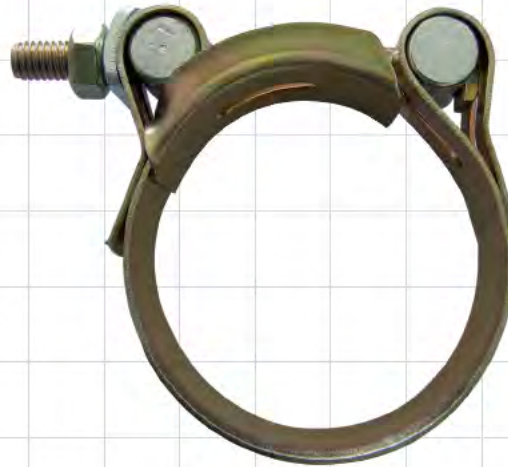

48 51



52 55



56 59

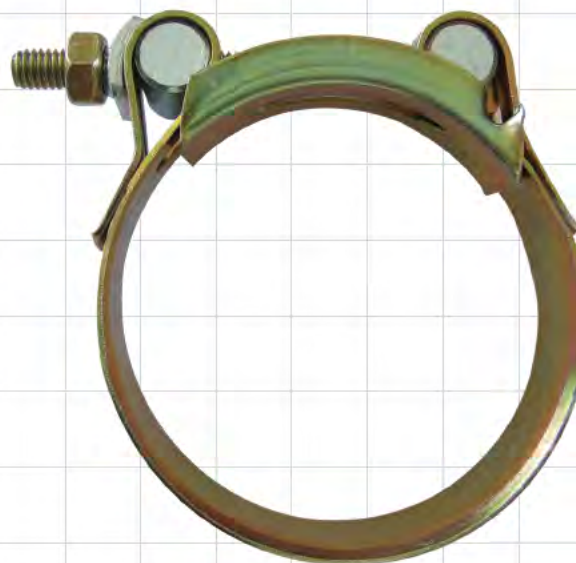

60 63

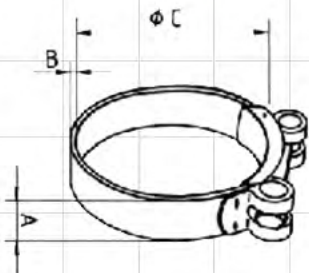

Art. No.	Amm	Bmm	Cmm Ømenor a mayor	Ø tornillo
537 26 28	21	1	26 - 28	M 6
537 29 31	21	1	29 - 31	M 6
537 32 35	21	1	32 - 35	M 6
537 36 39	21	1	36 - 39	M 6
537 40 43	21	1	40 - 43	M 6
537 44 47	21	1	44 - 47	M 6
537 48 51	21	1	48 - 51	M 6
537 52 55	21	1	52 - 55	M 6
537 56 59	21	1	56 - 59	M 6
537 60 63	21	1	60 - 63	M 6
537 64 67	21	1,5	64 - 67	M 6

Art. No.	Amm	Bmm	Cmm Ømenor a mayor	Ø tornillo
537 68 73	24	1,5	68 - 73	M 8
537 74 79	24	1,5	74 - 79	M 8
537 80 85	24	1,5	80 - 85	M 8
537 86 91	24	1,5	86 - 91	M 8
537 92 97	24	1,5	92 - 97	M 8
537 98 103	24	1,5	98 - 103	M 8
537 104 112	24	1,5	104 - 112	M 8
537 113 121	24	1,5	113 - 121	M 8
537 122 130	24	1,5	122 - 130	M 8
537 149 161	26	1,8	149 - 161	M 8

**FAMILIA N°. 040 Tornillo Cilíndrico Plano de Acero Cincado
DIN 84 Clase 4.8 Grado 5**

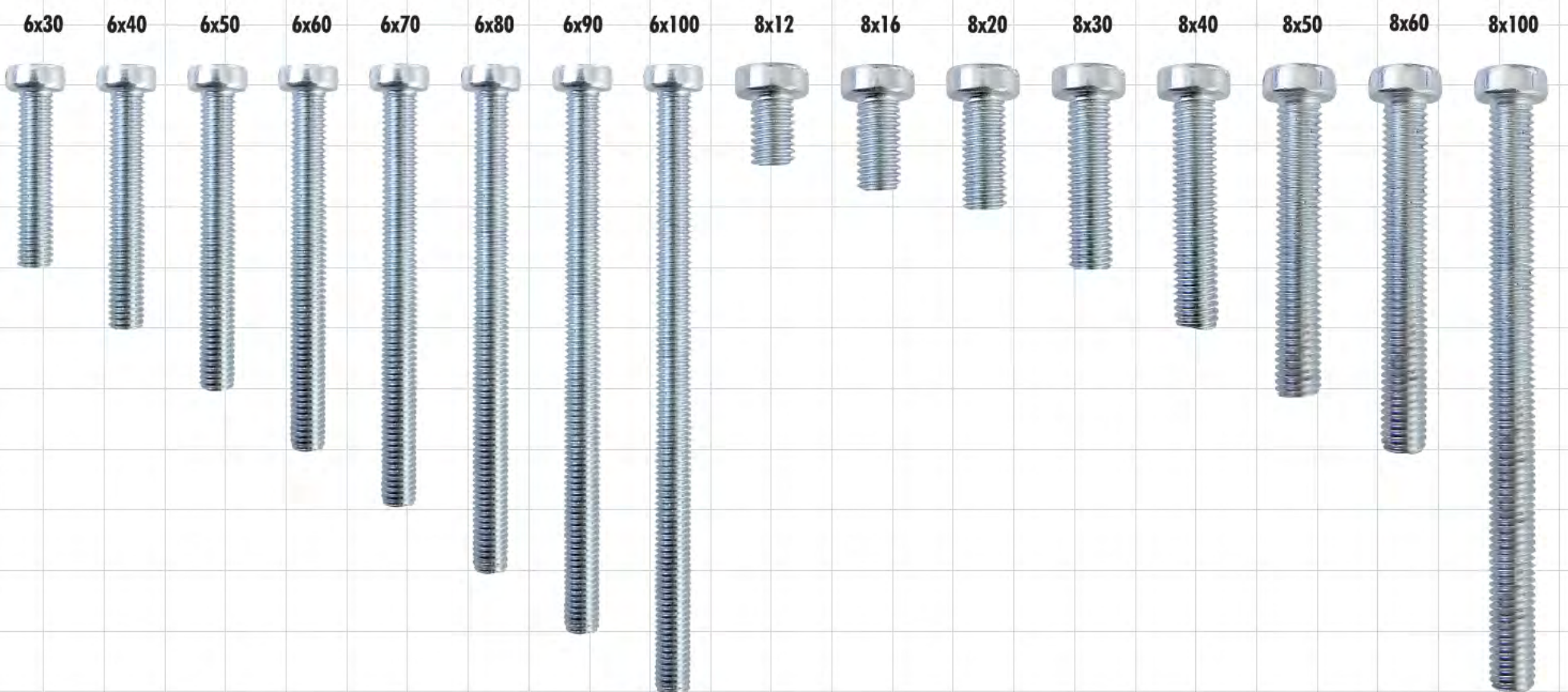
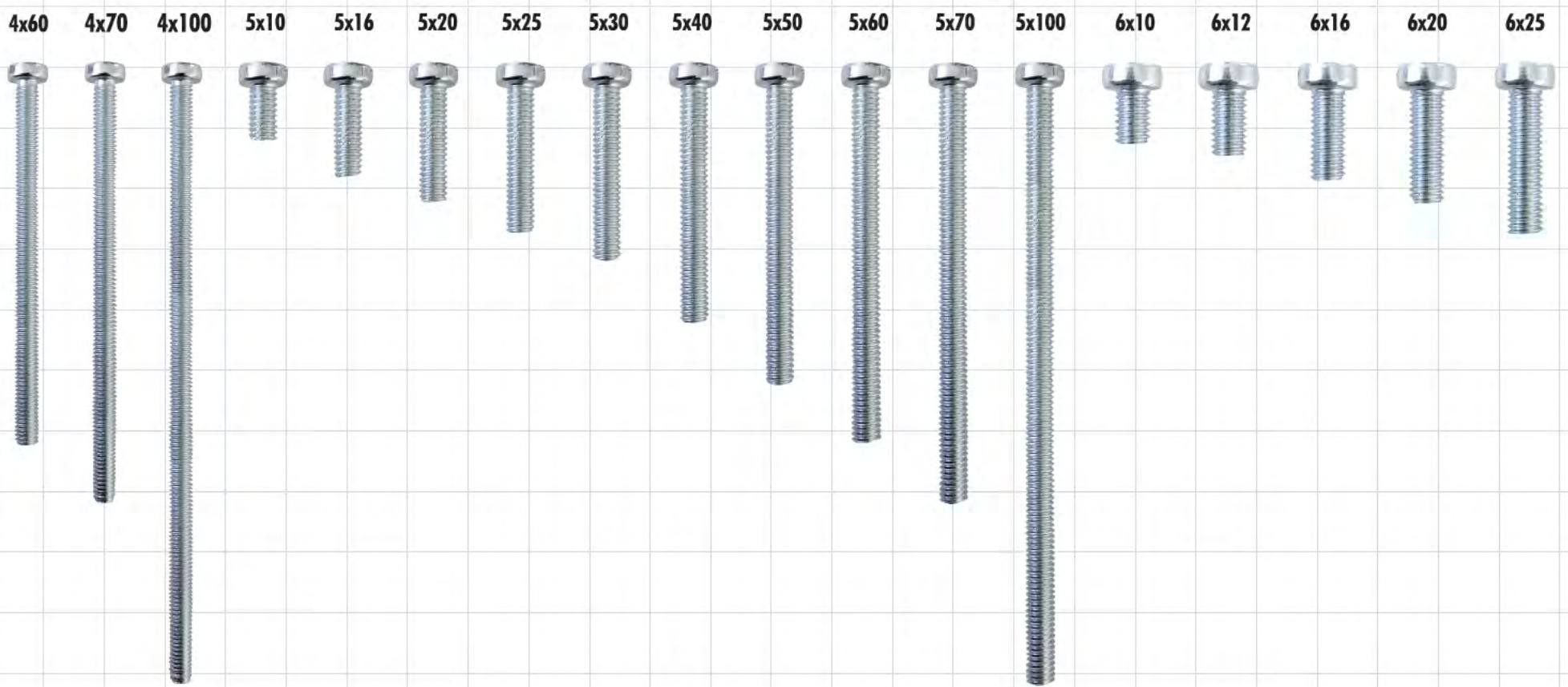
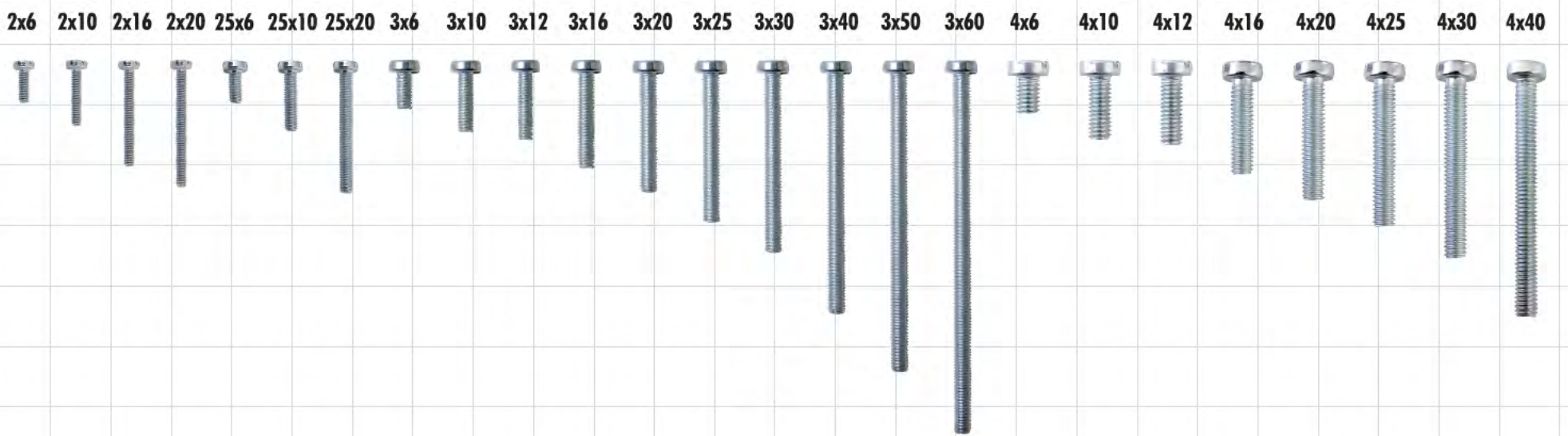

FAMILIA No. 542 Abrazaderas de Acero Cincado con Cubierta de Goma

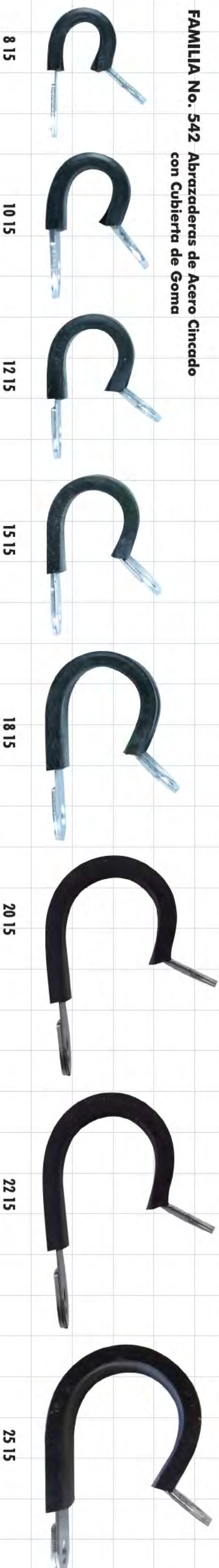

8 15

10 15

12 15

15 15

18 15

20 15

22 15

25 15



35 15



40 15



50 25

FAMILIA No. 535 Abrazaderas CLIC



55 80

55 90

66 100

66 110

66 120

66 130

86 140

86 170

86 200

86 210

86 235

547 000 10

8 mm x 5 mts

547 000 011

Fleje y tensor de Abrazadera



FAMILIA No. 502 Abrazaderas de Nylon y Complementos



121 L. 140 mm D. 1.6 a 30 mm
 141 L. 178 mm D. 1.6 a 40 mm
 131 L. 178 mm D. 1.6 a 40 mm
 151 L. 240 mm D. 1.6 a 75 mm
 161 L. 370 mm D. 1.6 a 100 mm
 181 L. 370 mm D. 1.6 a 100 mm

418 9 530 9 618 9 750 9 818 9 840 9 115 09

291 2 L. 197 mm D. 1.6 a 45 mm
 271 1 L. 184 mm D. 4.5 a 45 mm

241 0 L. 360 mm D. 1.6 a 102 mm
 251 0 L. 338 mm D. 4.8 a 90 mm
 231 L. 186 mm D. 1.6 a 45 mm
 221 L. 140 mm D. 1.6 a 90 mm
 211 L. 80 mm D. 1.6 a 16 mm

Con Seguro de Acero

71

72

648

636

92

840 10*

* El color del Art. No. 502 840 10 puede variar y el folio no es consecutivo

FAMILIA No. 558 Terminales eléctricas y complementos

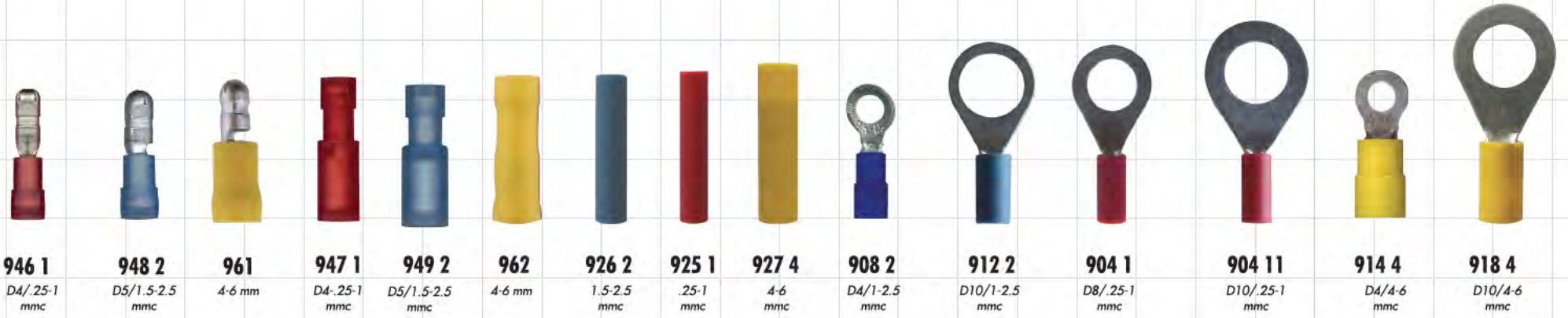

FAMILIA No. 967 Terminales Eléctricas



Calibre de Terminales Eléctricas

10-12 14-16 18-20

FAMILIA No. 555 Conectores de Arnés y Derivados

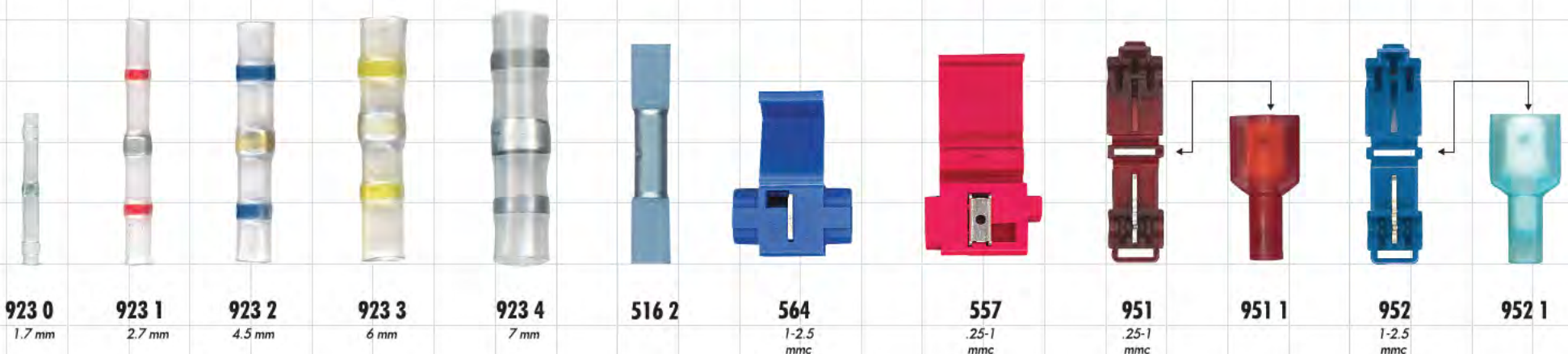

FAMILIA No. 558 Terminales eléctricas y complementos



FAMILIA No. 557 Terminal Desnuda Estañada de Ojillo



FAMILIA No. 510 Terminales Galvanizada para Batería

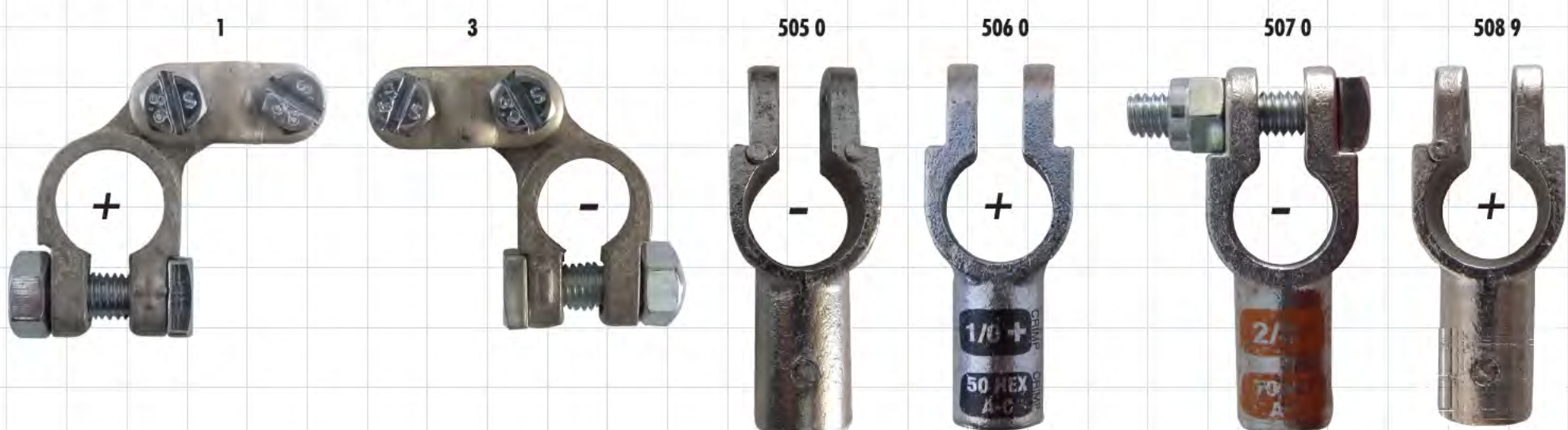

FAMILIA No. 731 Fusibles de Muela y Enchufe (Mini, Normal y Maxi)

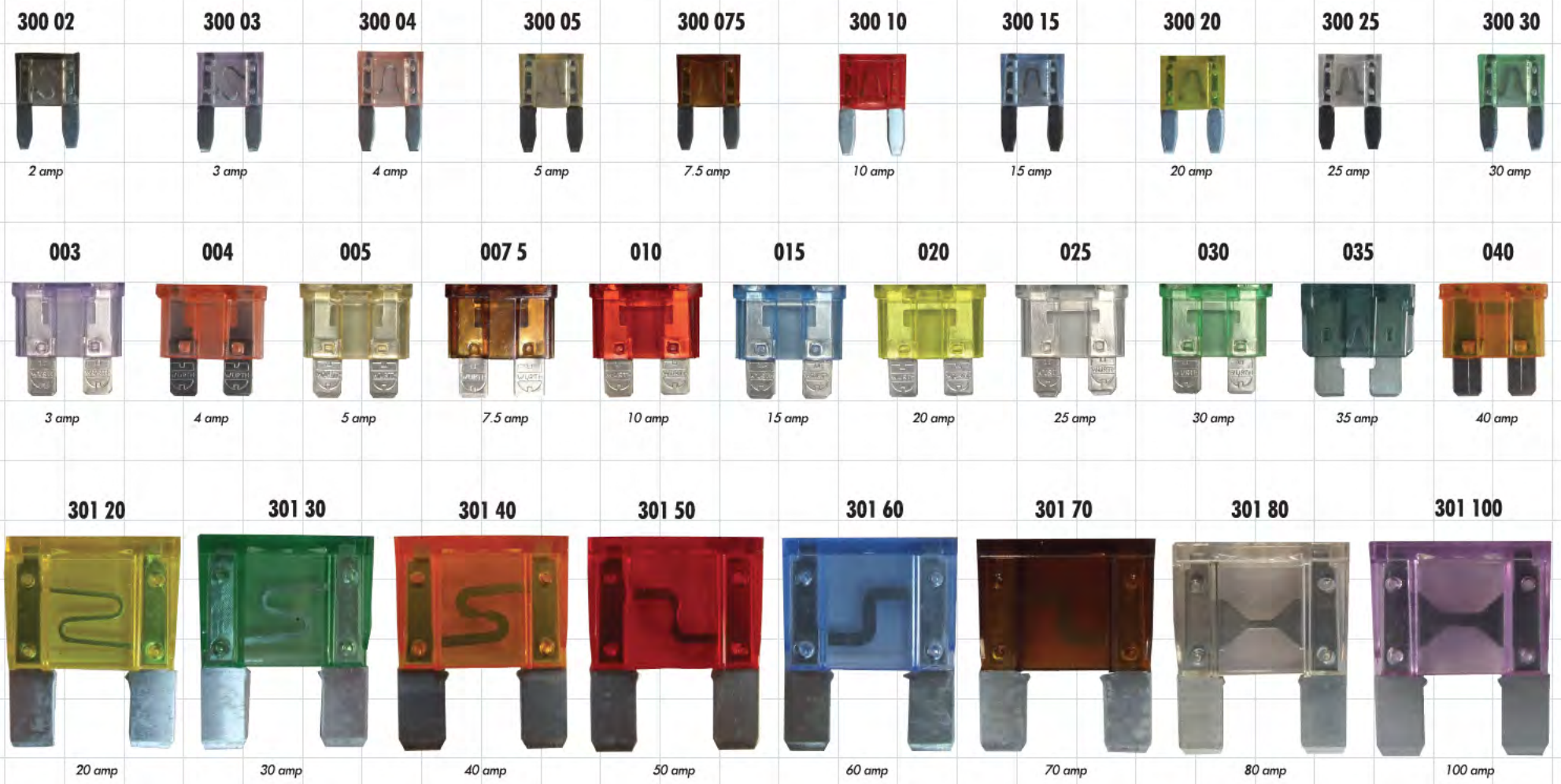

FAMILIA No. 730 Fusibles de Cerámica (Huesito)



FAMILIA No. 555 Porta Fusible

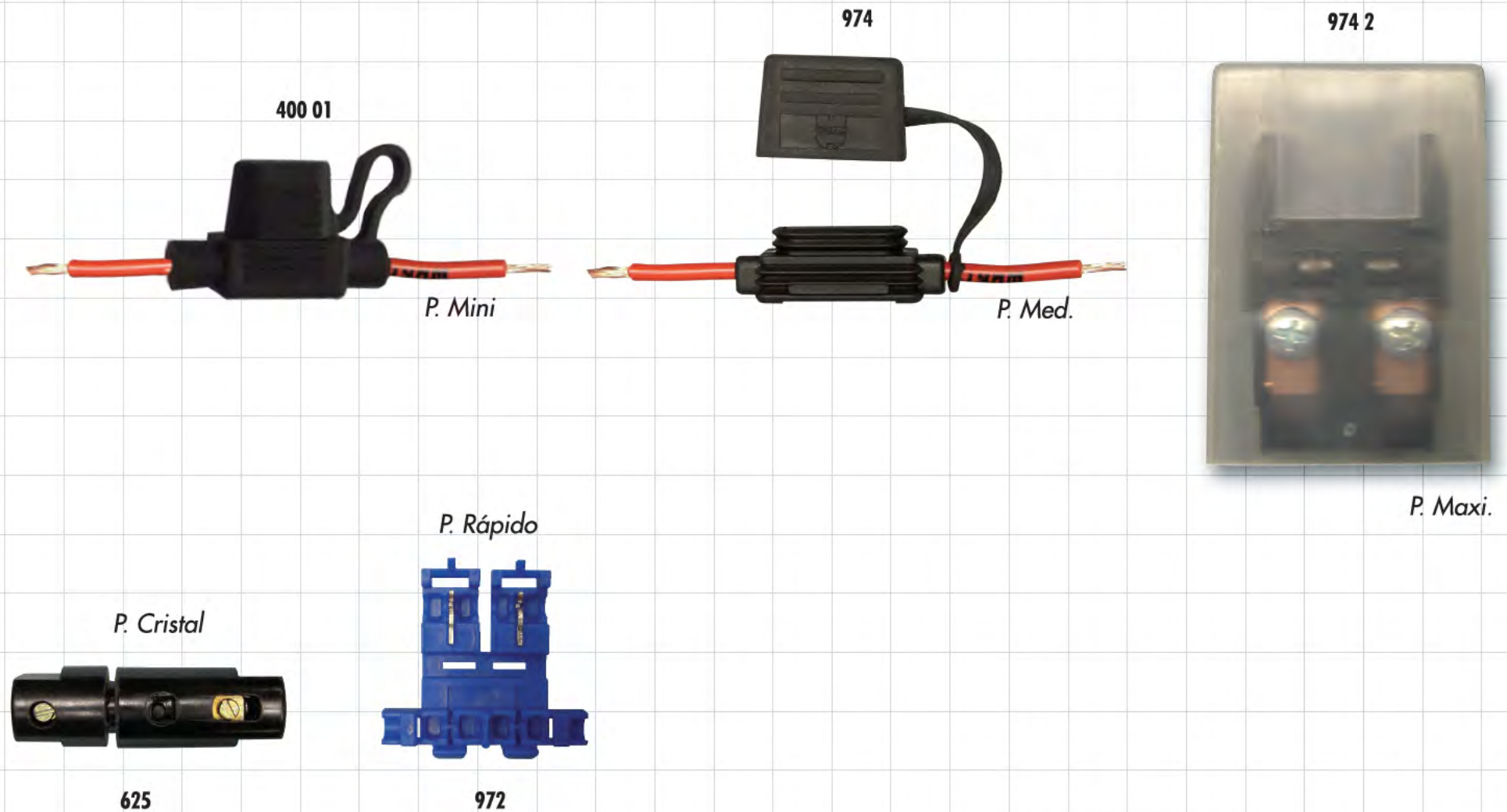

FAMILIA No. 985 Cintas Aislantes

Cinta de Teflón
030 165



Cinta PVC
101

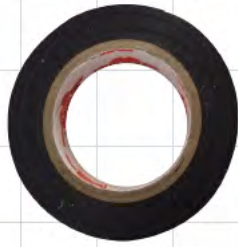

196

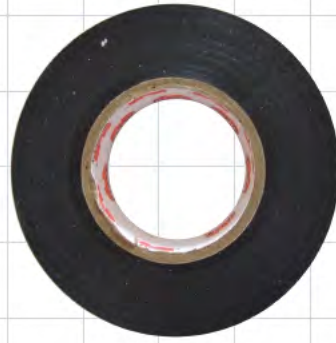

Cinta Aislante Autovulcanizante
077 1



030 150



Cont. 150 mts.

Art. No.	Medidas
985 030 160	12mmx12mmx0.1mm
985 030 165	12mmx12mmx0.08mm

Art. No.	Color
985 103	Red
985 105	Blue
985 107	Yellow
985 101	Black

Art. No.	Color
985 191	Red
985 192	Blue
985 194	Yellow
985 196	Black

Art. No.	Ancho
985 077 1	19 mm
985 077 2	38 mm

FAMILIA No. 770 Cable Aislado Varios Calibres

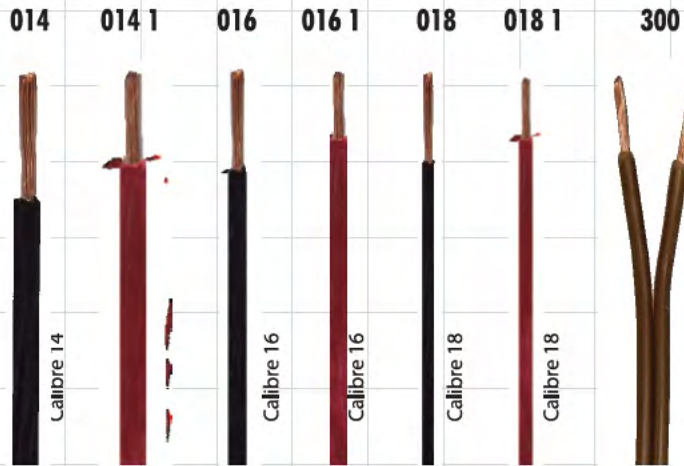

FAMILIA No. 555 Derivaciones para Terminales

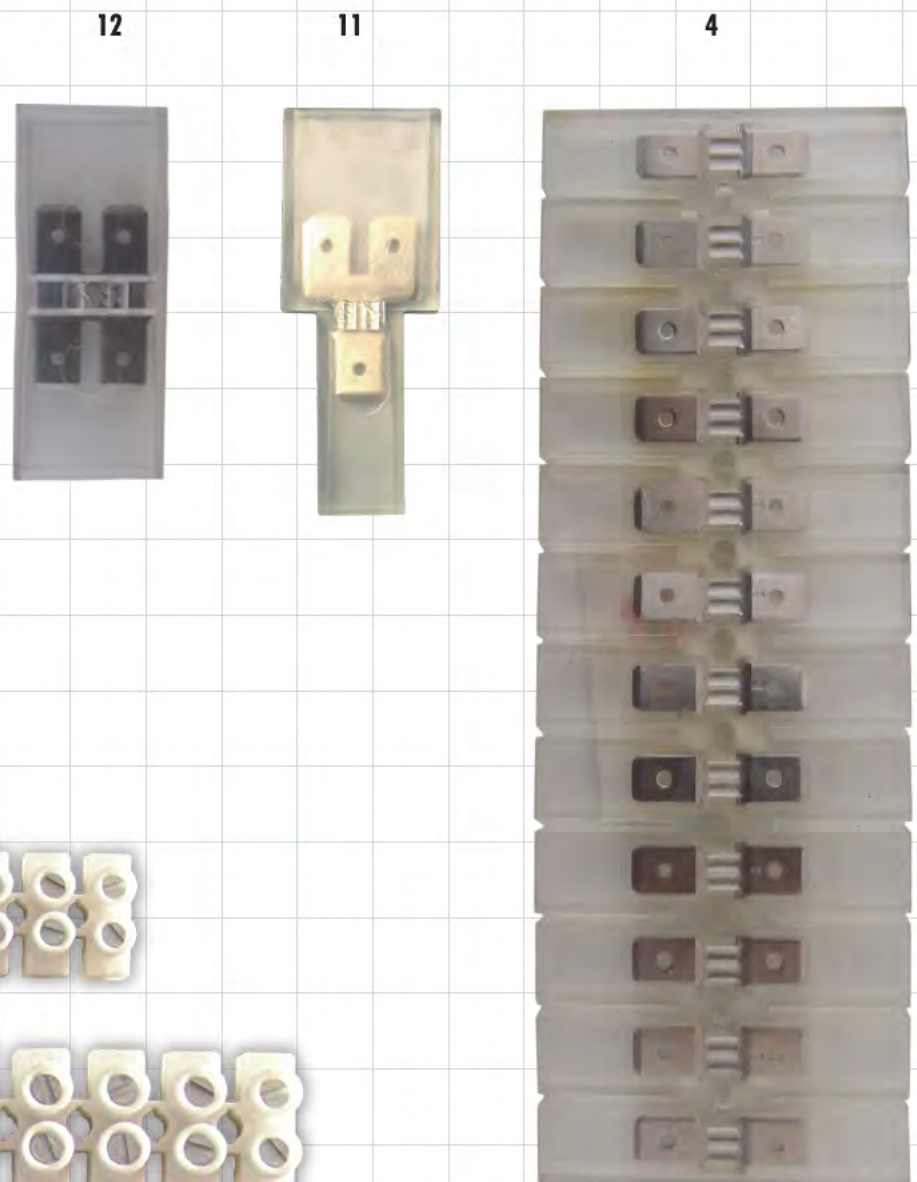

FAMILIA No. 556 Regleta de Conexión con 12 Polos

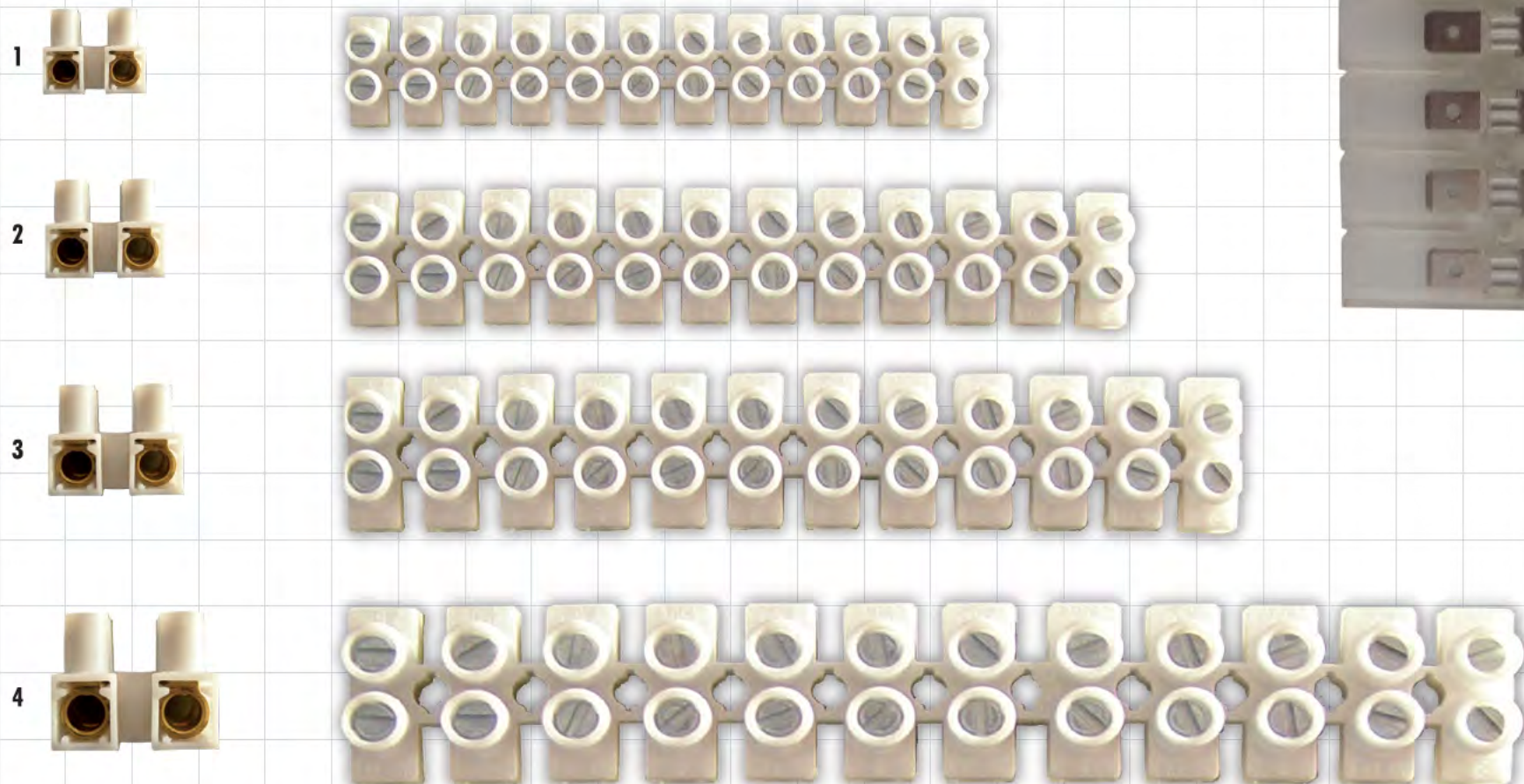

FAMILIA No. 555 Conectores de Arnés

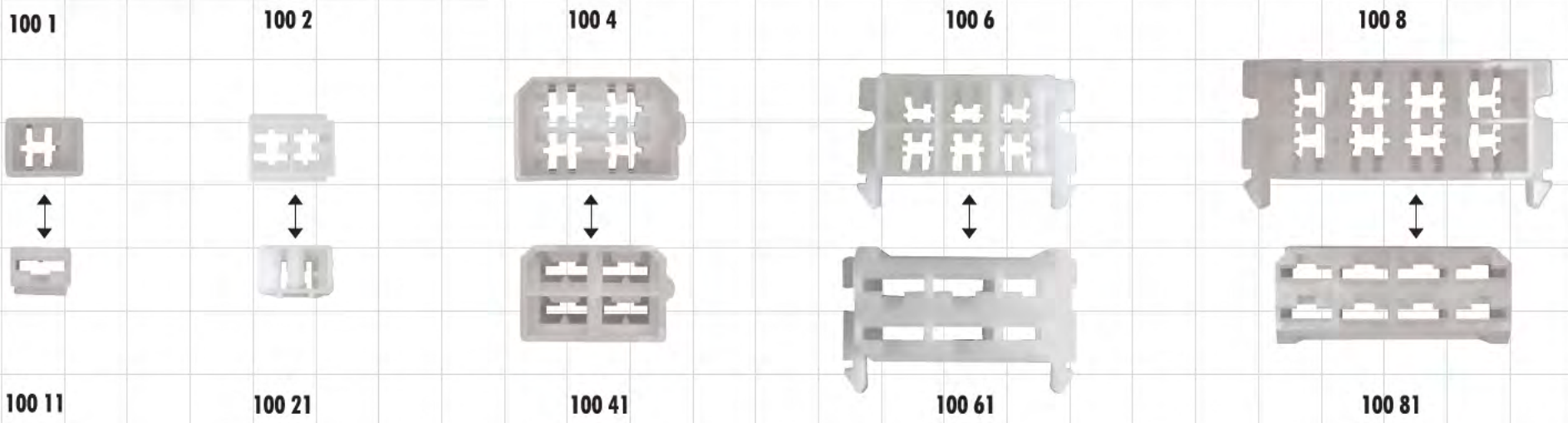

FAMILIA No. 771 Funda Termocontráctil (por pieza y por metro)

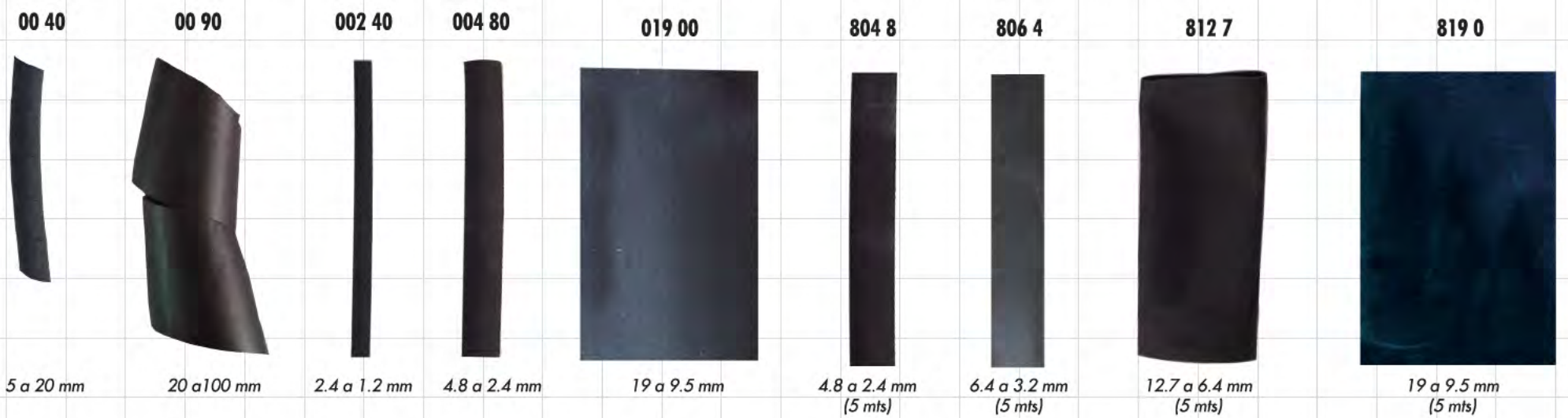

003 20: 3.2 mm a 1.6 mm

Art. No.	Color
771 870 032	Blue
771 871 032	Red
771 872 032	Yellow
771 874 032	Green/Yellow

006 40: 6.4 mm a 3.2 mm

Art. No.	Color
771 870 064	Blue
771 871 064	Red
771 872 064	Yellow
771 874 064	Green/Yellow

012 70: 12.7 mm a 6.4 mm

Art. No.	Color
771 870 127	Blue
771 871 127	Red
771 872 127	Yellow
771 874 127	Green/Yellow

870 254: 25.4 mm a 12.7 mm

Art. No.	Color
771 871 254	Red
771 872 254	Yellow
771 874 254	Green/Yellow



FAMILIA No. 561 Pasamuro de caucho nitrílico laterales y de dos lados.

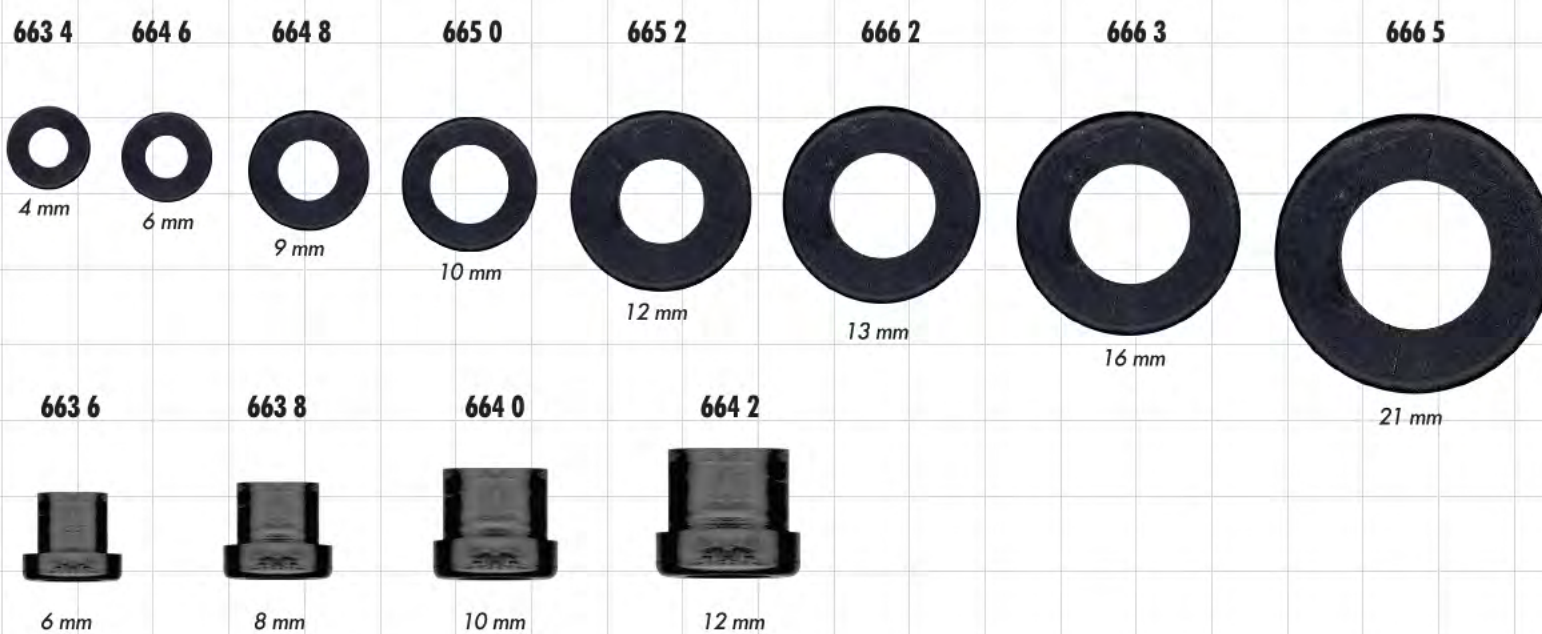

FAMILIA No. 998 Conector de 2 Vías

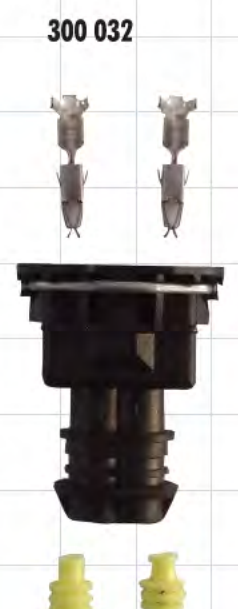

FAMILIA No. 614 Puntas Intercambiables y Complementos

Punta XZN 3/8
Longitud 75 mm



788 506
M6

788 508
M8

788 510
M10

788 512
M12

Punta Torx 3/8
Longitud 75 mm

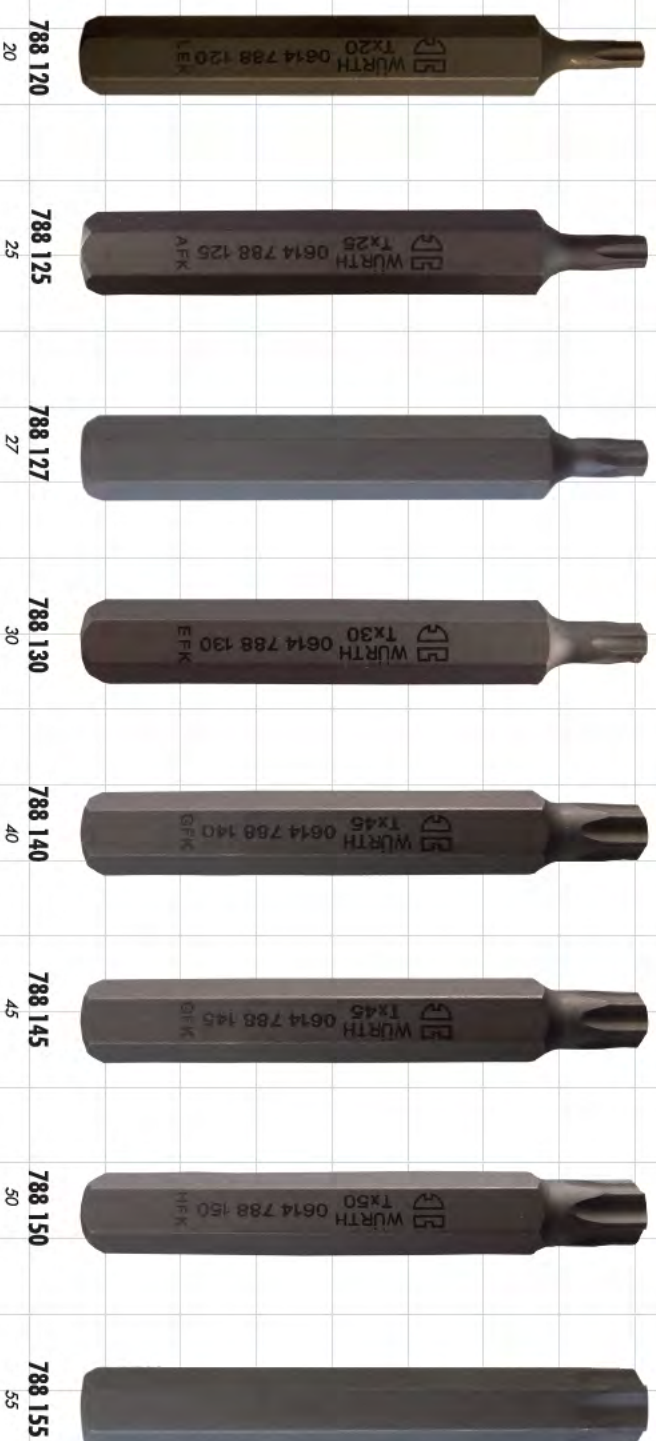

788 120
20

788 125
25

788 127
27

788 130
30

788 140
40

788 145
45

788 150
50

788 155
55

Punta Torx 3/8
Longitud 120 mm



788 240
40

788 245
45

788 250
50

FAMILIA No. 616 Fresas Metálicas

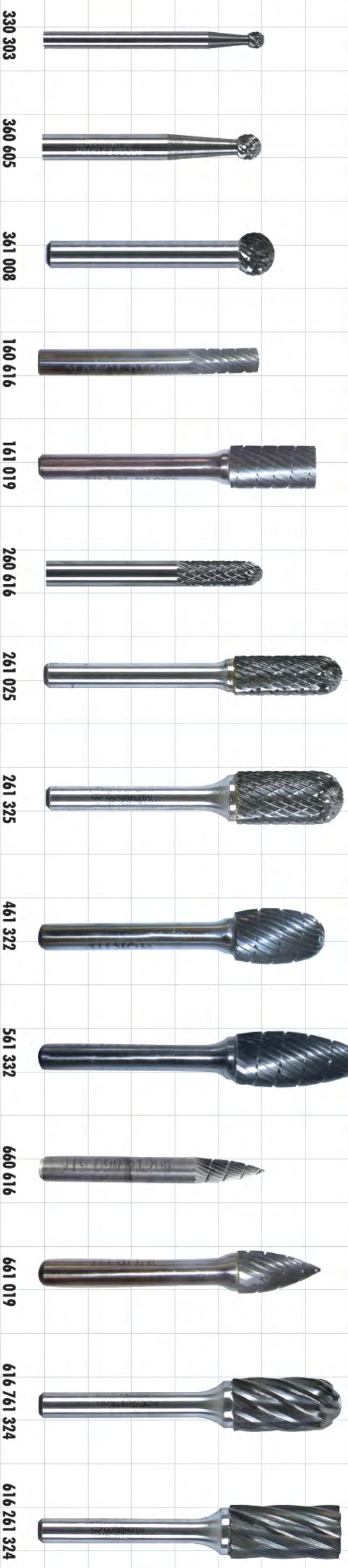

330 303

360 605

361 008

160 616

161 019

260 616

261 025

261 325

461 322

561 332

660 616

661 019

616 761 324

616 261 324

FAMILIA No. 680 Fresas de Esmeril (Cerámica)

Conjunto de Puntas de Cerámica Dura (Art. No. 680 10)



21

31

41

51

61

71

72

73

77

Fresas de 1/8

Fresas de 1/4



13 3

1/8
13x3

20 6

1/8
20x6

8 10

1/8
8x10

10 13

1/8
10x13

5 13

1/8
5x13

13 201

1/8
13x20

13 20

1/8
13x20

6 20

1/4
6x20

6 27

1/4
6x27

16

1/4
16 mm

30 6

1/4
30x6

40 10

1/4
40x10

20 13

1/4
20x13

20 25

1/4
20x25

25 25

1/4
25x25

18 30

1/4
18x30

20 30

1/4
20x30

30 30

1/4
30x30

20 45

1/4
20x45

20 65

1/4
20x65

FAMILIA No. 694 Avellanadores

Avellanador 90°



810 06

810 08

810 010

810 012

810 016

810 020

810 025

810 031

815 02

815 03

815 04



**FAMILIA N° 046 Tornillo Cilíndrico Cruz (Phillips) de Acero Cincado
DIN 7985 Clase 8.8 Grado 5**

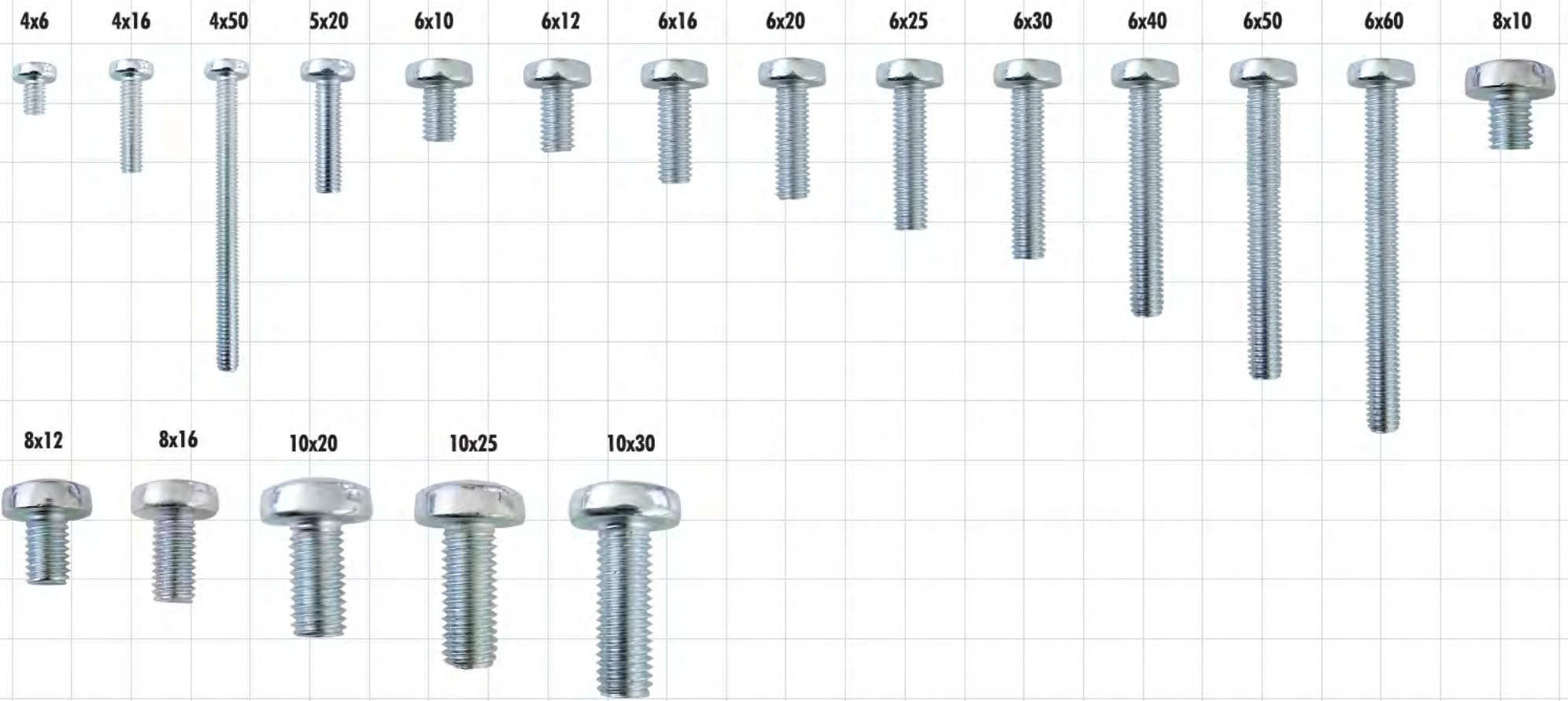

**FAMILIA N° 223 Tornillo Cabeza de Coche de Acero Cincado
DIN 603**

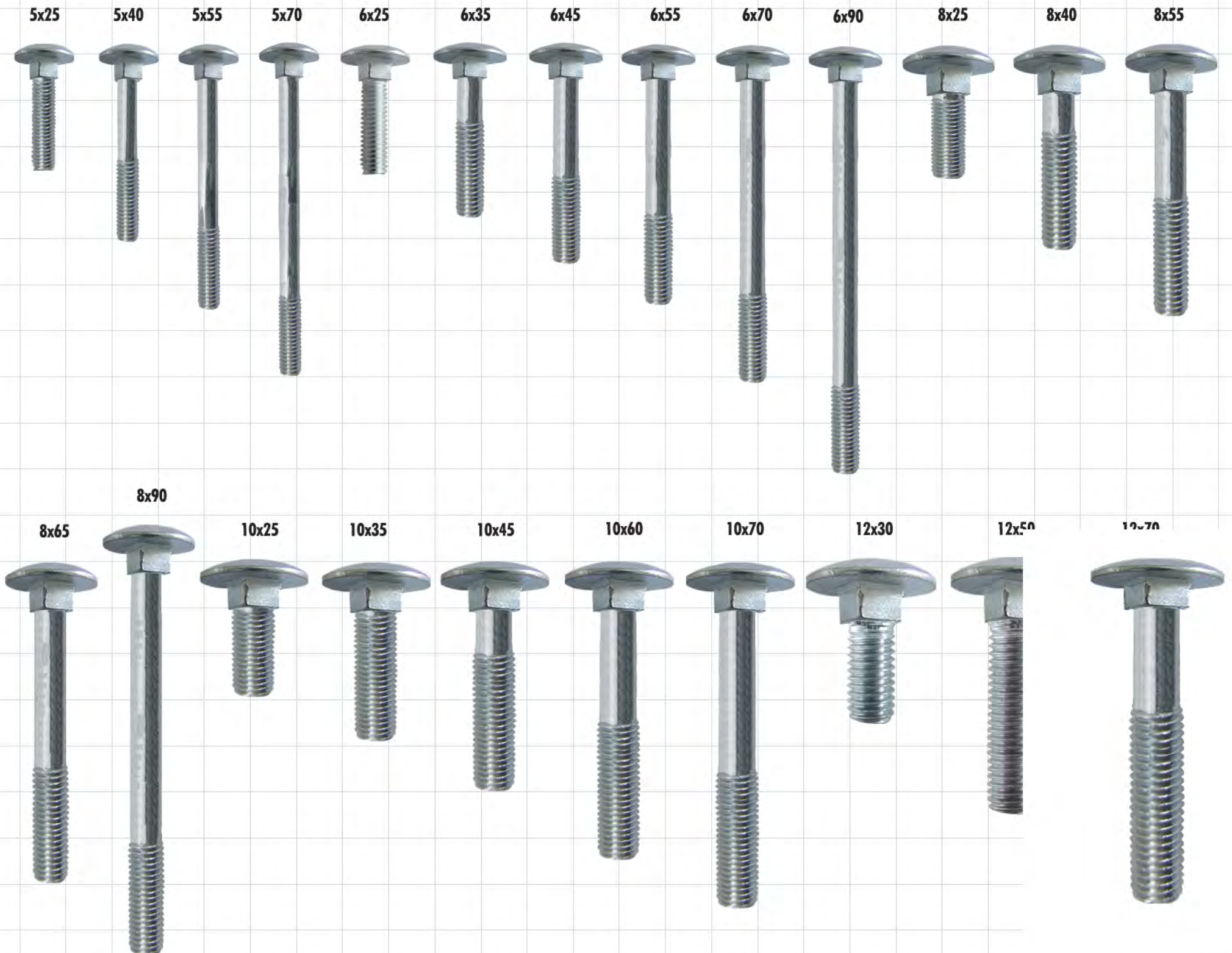

FAMILIA No. 694 Fresas Cónicas y Escalonadas

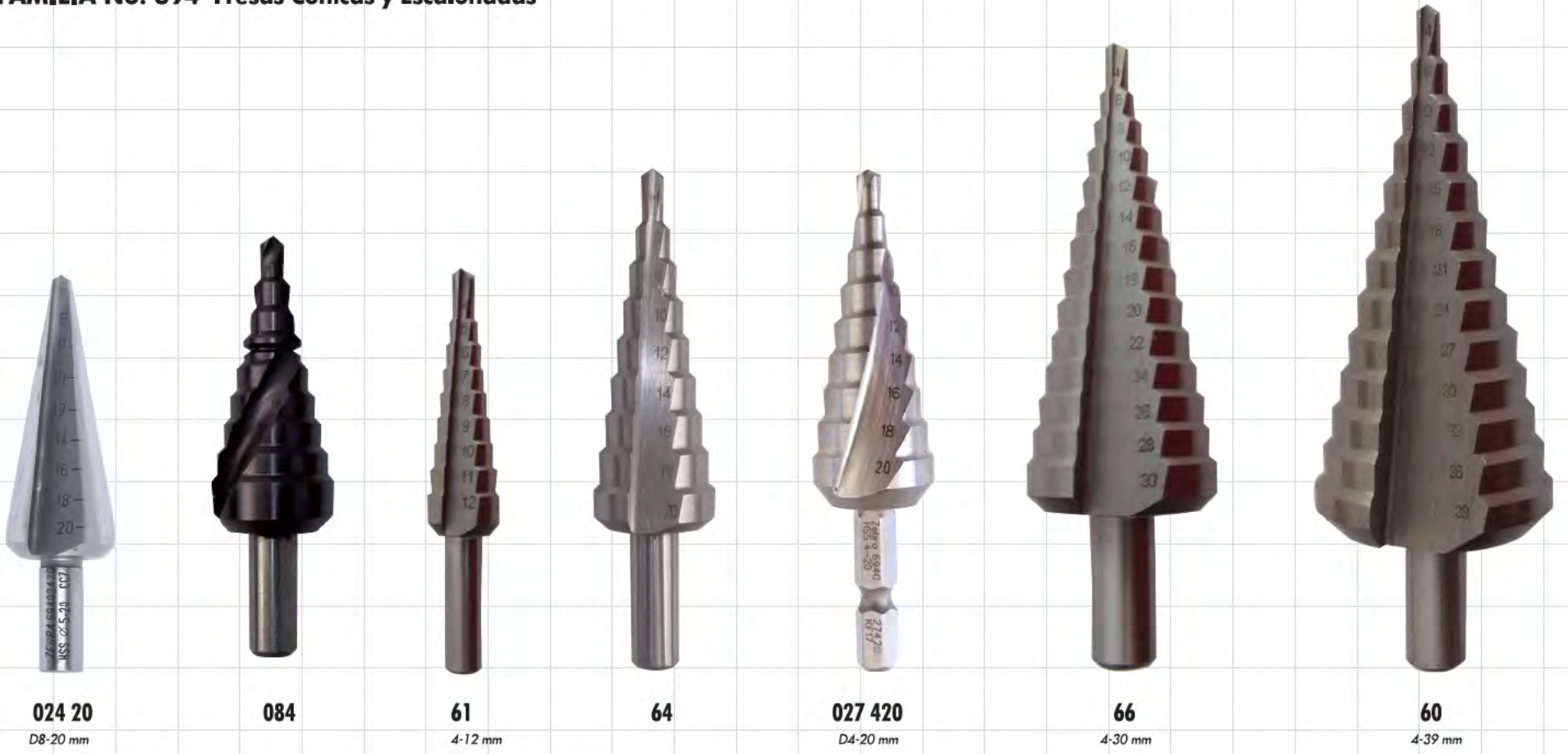

024 20
D8-20 mm

084

61
4-12 mm

64

027 420
D4-20 mm

66
4-30 mm

60
4-39 mm

FAMILIA No. 639 Machuelos Rectos y Semicónicos HSS

Juego de 3 Machuelos Milimétricos (Ø)



3
3 mm

4
4 mm

5
5 mm

6
6 mm

8
8 mm

10
10 mm

12
12 mm

FAMILIA No. 624 Machuelo de Máquina de Acero HSS DIN 371



3
3x52
Paso 0.5

4
4x59
Paso 0.7

5
5x64
Paso 0.8

6
6x68
Paso 1

8
8x78
Paso 1.25

10
10x95
Paso 1.5

12
12x115
Paso 1.75

14
14x112
Paso 2

16
16x112
Paso 2.5

18
18x135
Paso 2.5

20
20x135
Paso 2.5

22
22x140
Paso 2.5

24
24x160
Paso 3

FAMILIA No. 639 Machuelos HSS

Machuelos Rosca Cónica de Pulgadas (Ø)



160 1
1/8

160 2
1/4

160 3
3/8

160 4
1/2

160 5
3/4

160 6
1

160 7
1 1/4

160 8
1 1/2



160 9
2

FAMILIA No. 653 Machuelo Combinado

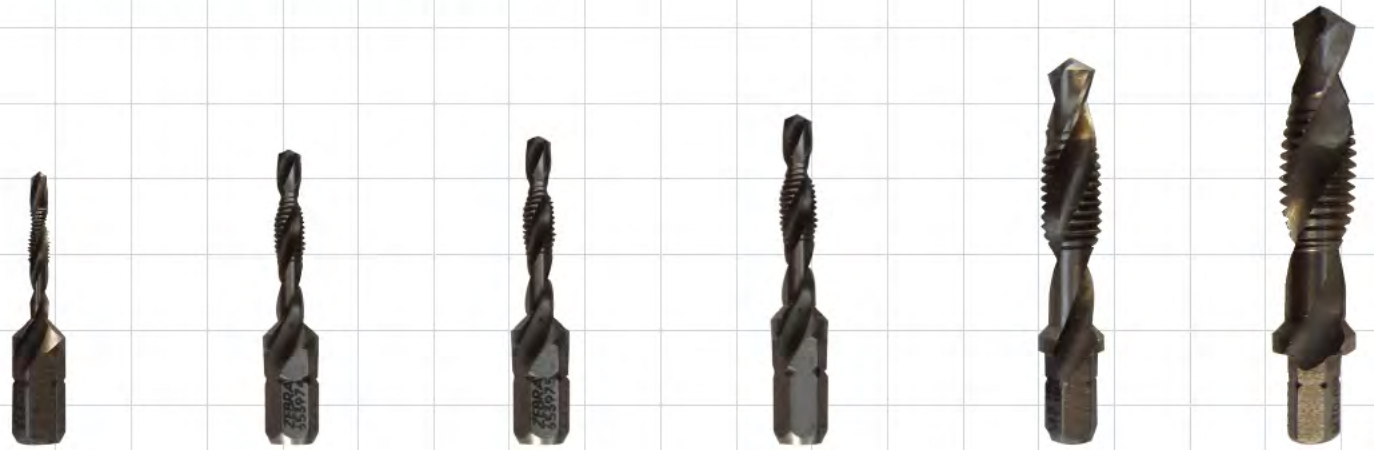

973

974

975

976

978

971 0

Ø R mm Rosca	Ø mm Broca	Long. mm
M3x0.5	2.5	36

Ø R mm Rosca	Ø mm Broca	Long. mm
M4x0.7	3.3	39

Ø R mm Rosca	Ø mm Broca	Long. mm
M5x0.8	4.2	41

Ø R mm Rosca	Ø mm Broca	Long. mm
M6x1.0	5	44

Ø R mm Rosca	Ø mm Broca	Long. mm
M8x1.25	6.8	50

Ø R mm Rosca	Ø mm Broca	Long. mm
M10x1.5	8.5	59

FAMILIA No. 630 Tarraja HSS Milimétrica DIN 223

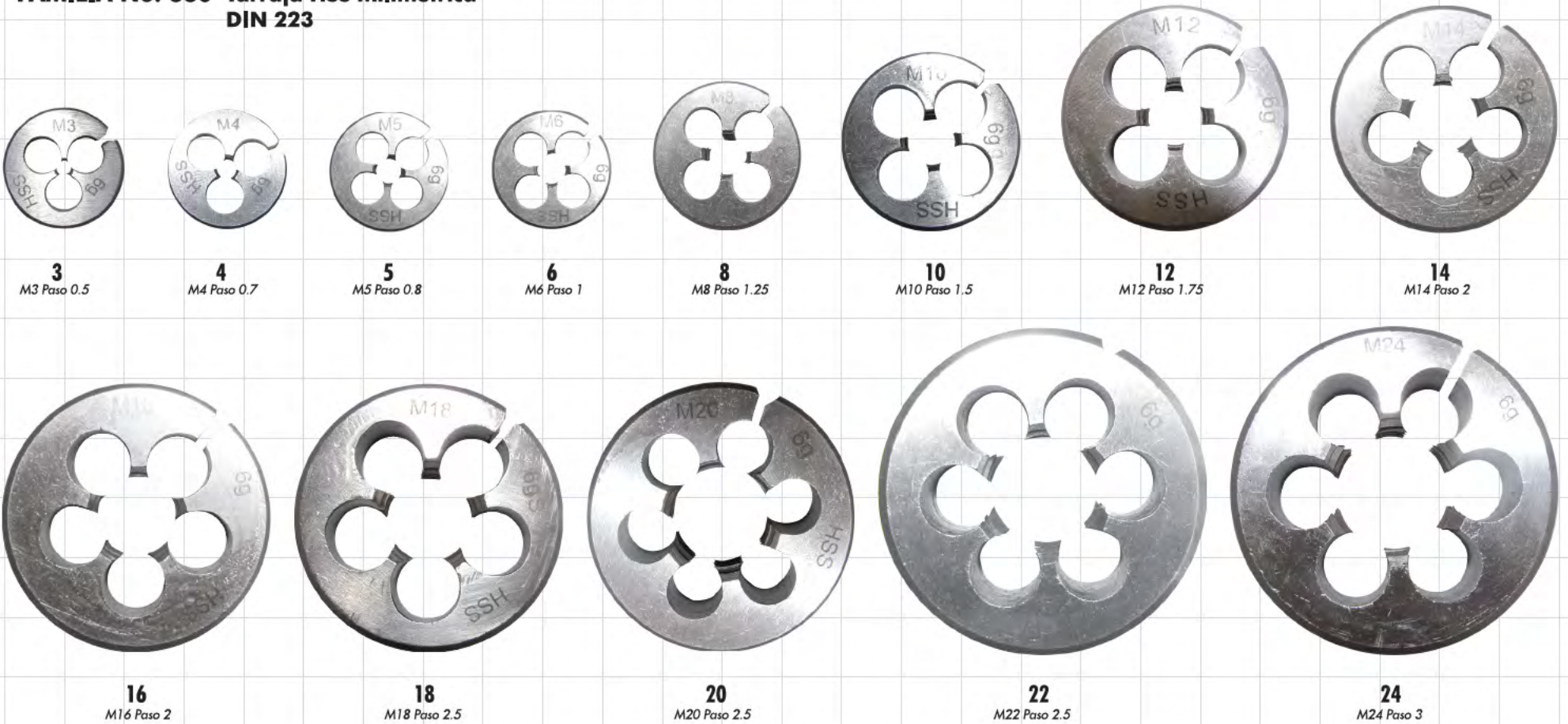

3
M3 Paso 0.5

4
M4 Paso 0.7

5
M5 Paso 0.8

6
M6 Paso 1

8
M8 Paso 1.25

10
M10 Paso 1.5

12
M12 Paso 1.75

14
M14 Paso 2

16
M16 Paso 2

18
M18 Paso 2.5

20
M20 Paso 2.5

22
M22 Paso 2.5

24
M24 Paso 3

FAMILIA No. 603 Seguetas Varias

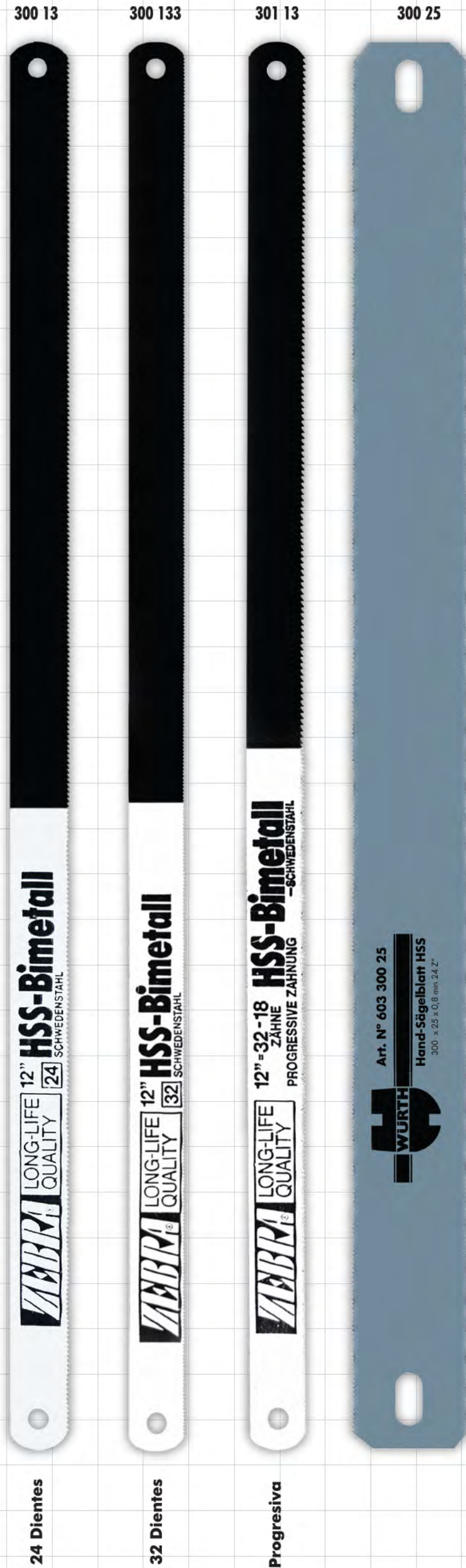

FAMILIA No. 608 Sierras Caladoras para Madera y Metal (Paq. de 5 piezas)

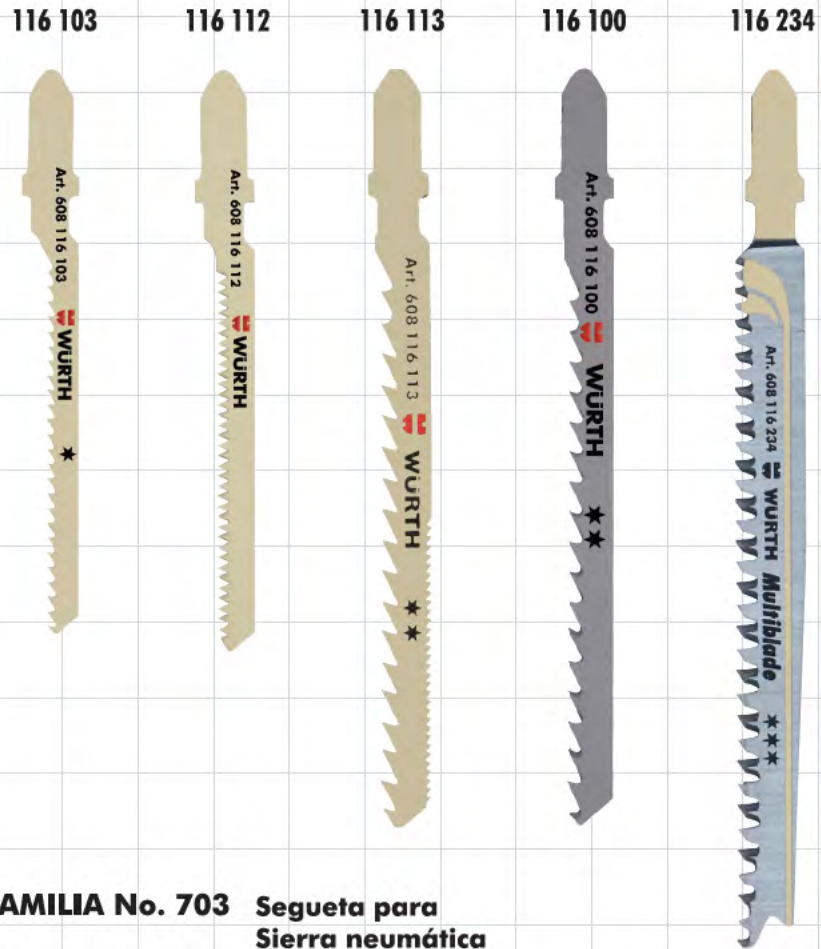

FAMILIA No. 703 Segueta para Sierra neumática

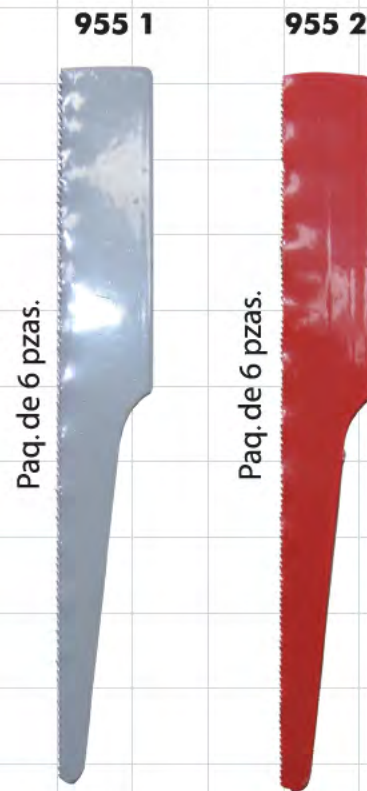

FAMILIA No. 615 Sierra Caladora Zebra para Madera

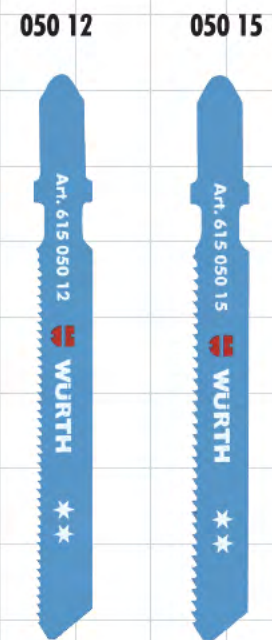

FAMILIA No. 698



FAMILIA No. 710 Brocas para Punto de Soldadura



FAMILIA No. 622 Brocas con Recubrimiento de Titanio

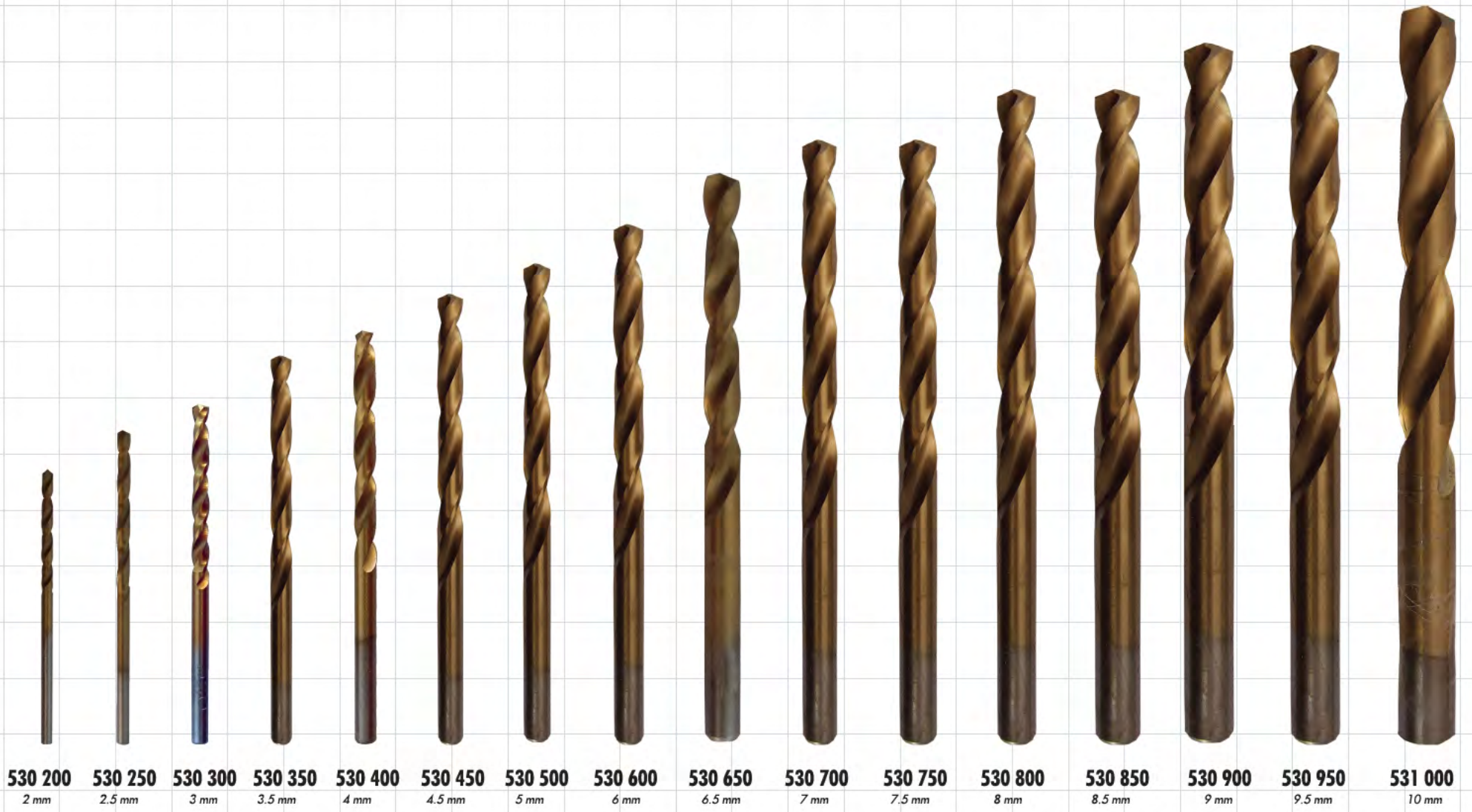

FAMILIA No. 641 Broca Universal

FAMILIA No. 620 Broca Universal Todo Material Plus



FAMILIA No. 625 Brocas Milimétricas Acero Rápido DIN 338

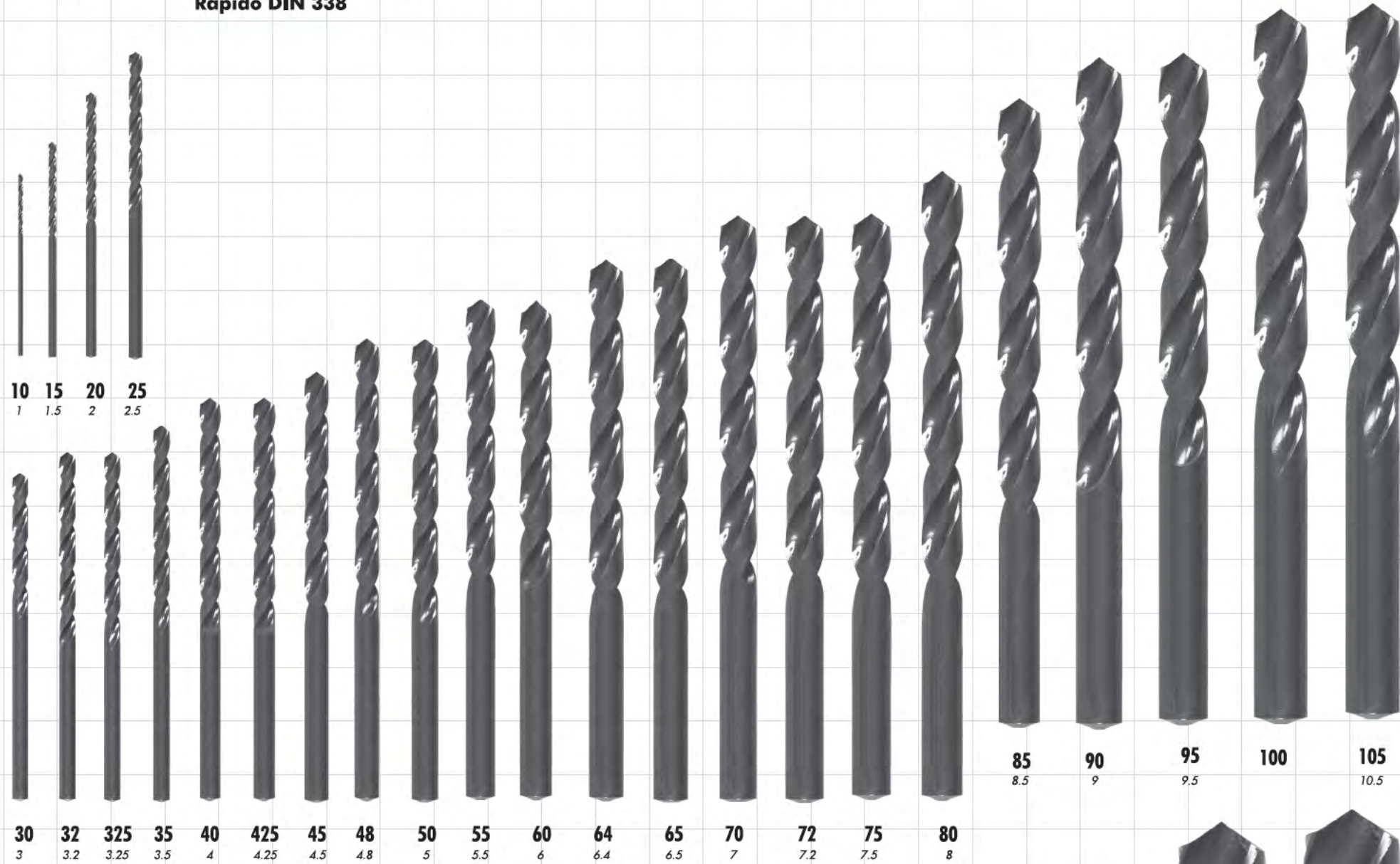

FAMILIA No. 625 Brocas en Pulgadas Acero Rápido DIN 338

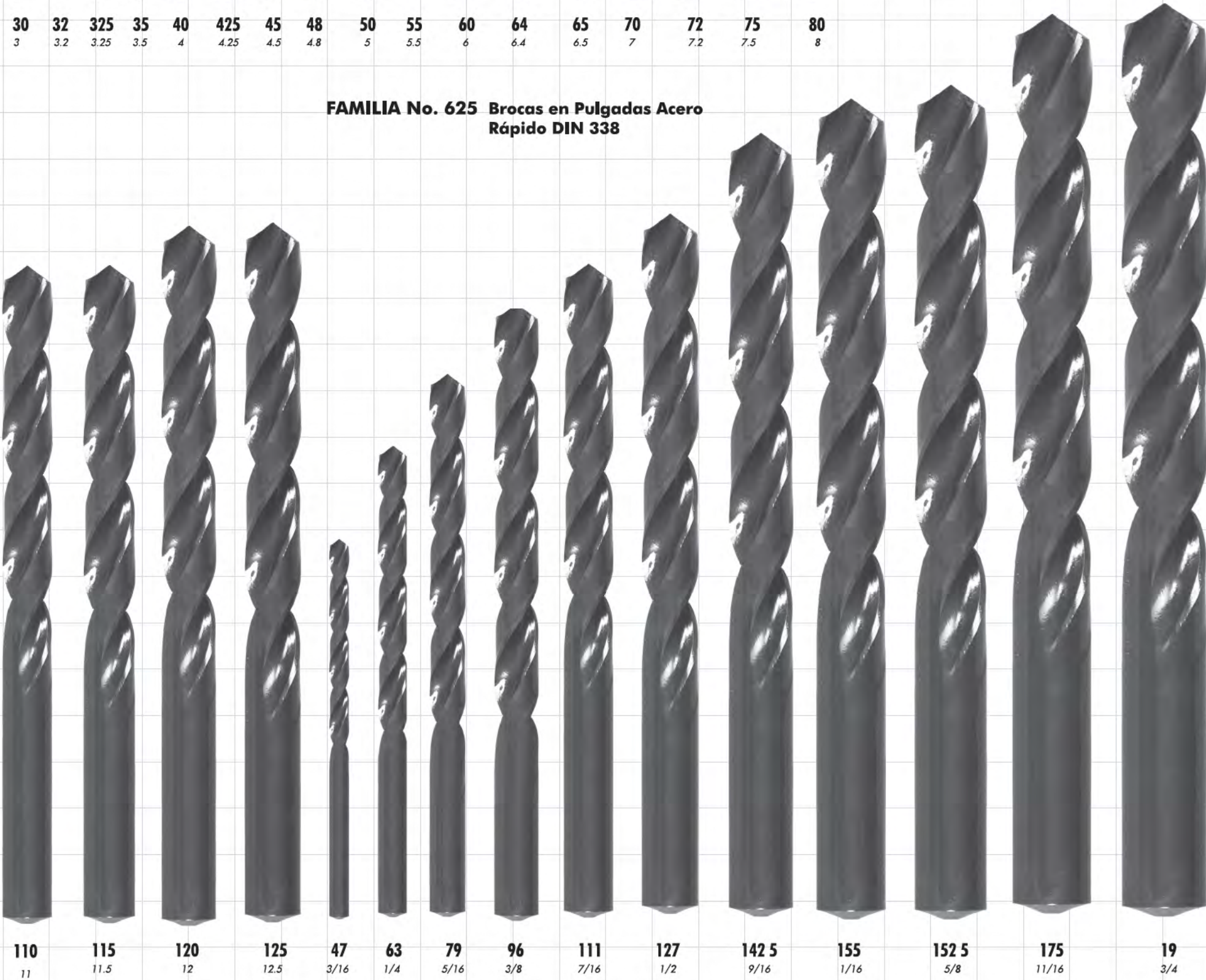

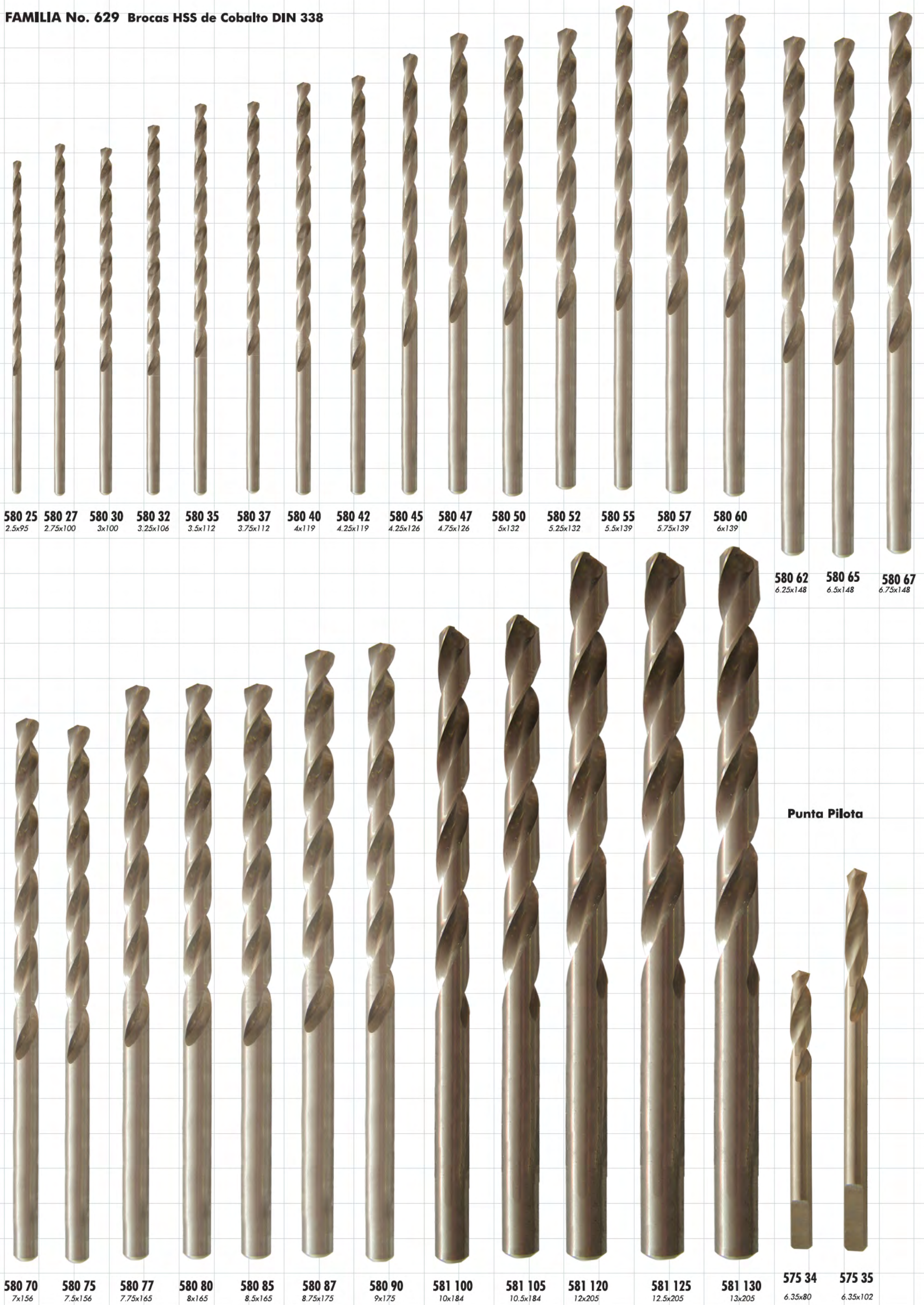
FAMILIA No. 629 Brocas HSS de Cobalto DIN 338

580 25 2.5x95
580 27 2.75x100
580 30 3x100
580 32 3.25x106
580 35 3.5x112
580 37 3.75x112
580 40 4x119
580 42 4.25x119
580 45 4.25x126
580 47 4.75x126
580 50 5x132
580 52 5.25x132
580 55 5.5x139
580 57 5.75x139
580 60 6x139

580 62 6.25x148
580 65 6.5x148
580 67 6.75x148

580 70 7x156
580 75 7.5x156
580 77 7.75x165
580 80 8x165
580 85 8.5x165
580 87 8.75x175
580 90 9x175
581 100 10x184
581 105 10.5x184
581 120 12x205
581 125 12.5x205
581 130 13x205

Punta Pilota

575 34 6.35x80
575 35 6.35x102

FAMILIA No. 626 Brocas HSS de Cobalto DIN 338

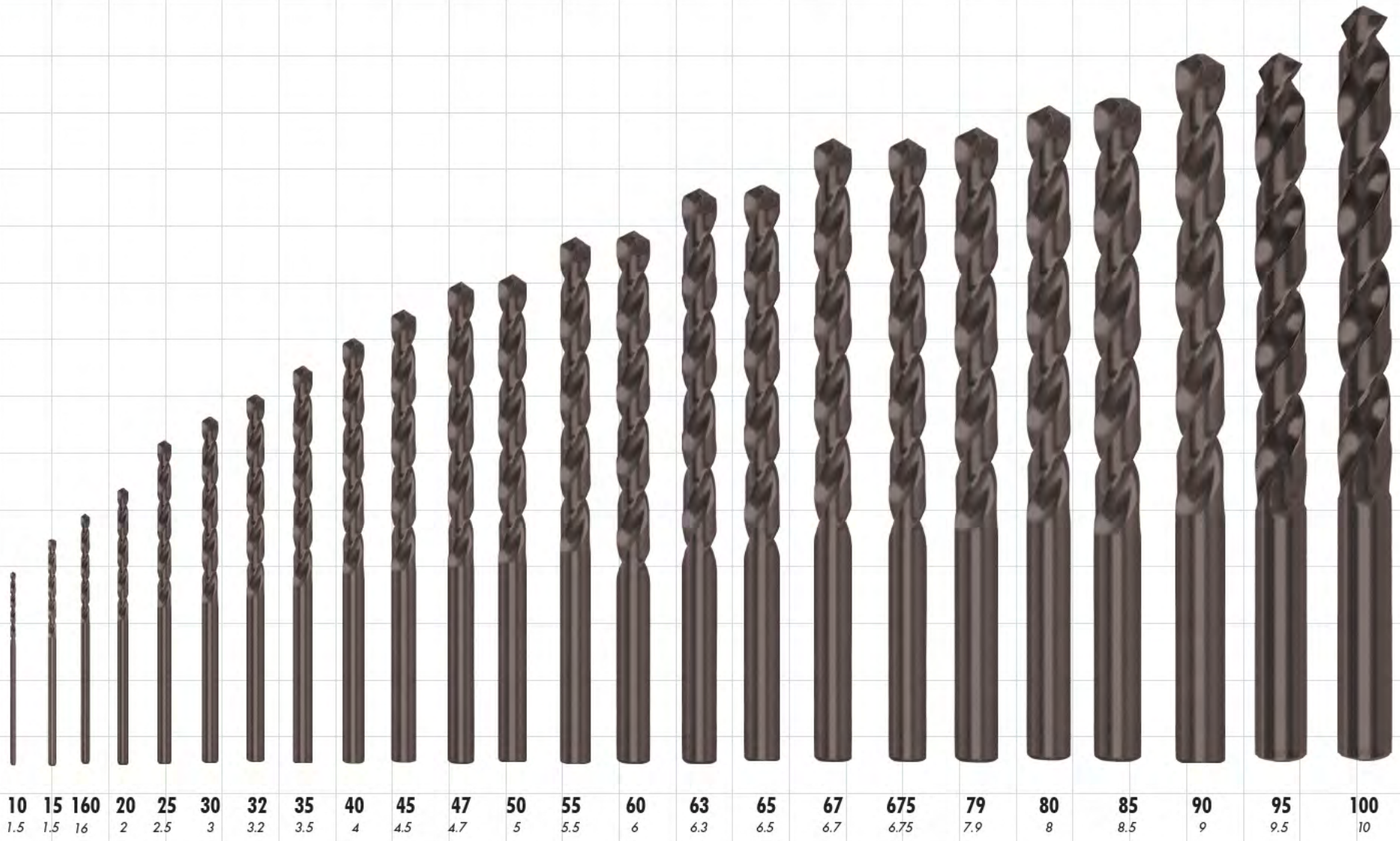

FAMILIA No. 648 Broca SDS para Roto Martillo doble canal

FAMILIA No. 637 Broca Profesional para Hormigón



FAMILIA No. 986 Graseras y Aplicadores

Milimétricas



Pulgadas



FAMILIA No. 891 Herramientas de Aplicación y Equipo para Inyección

Cedazos T.B.I. y M.P.F.I.

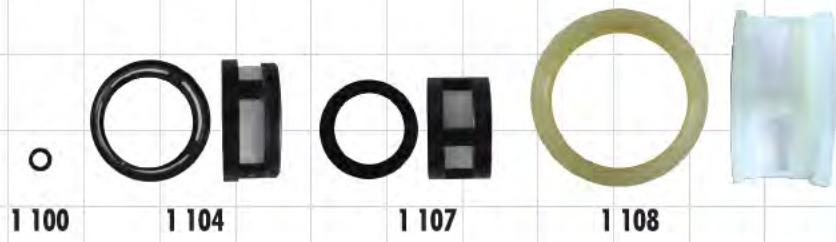

Toberas



Espaciador de Nylon

Soportes

O' Ring de Vitón

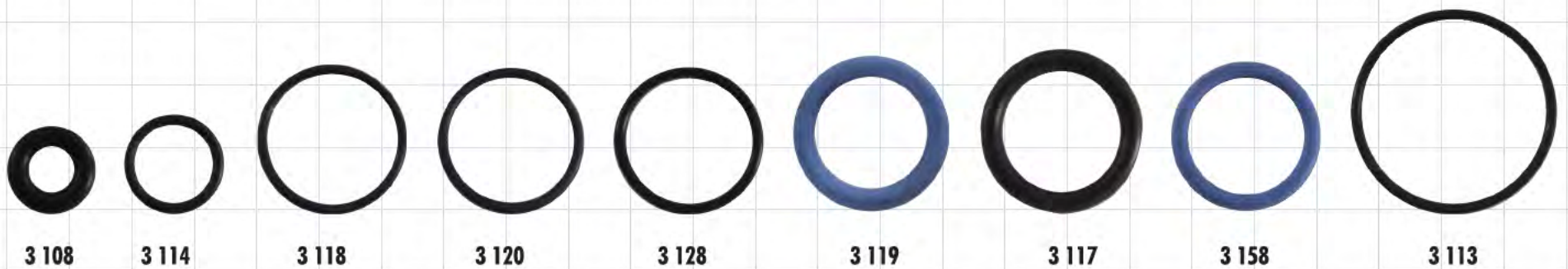

Sellos

Juntas

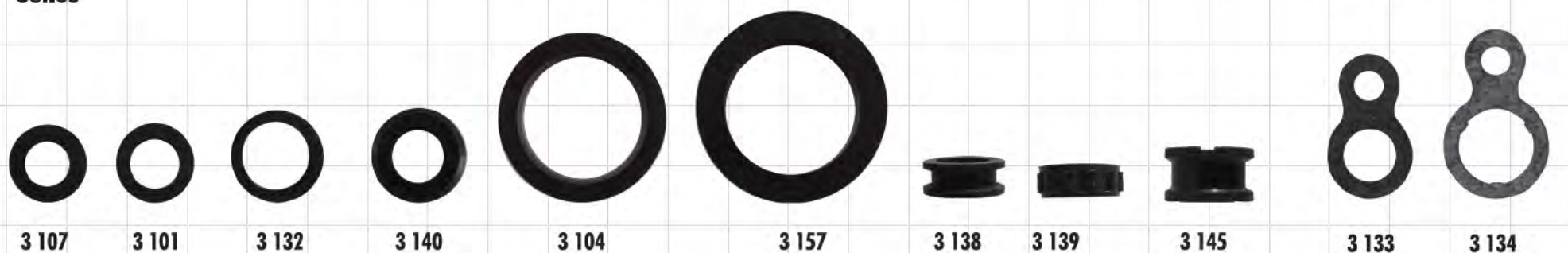

FAMILIA No. 891 Herramientas de Aplicación y Equipo para Inyección

Juntas



4 100

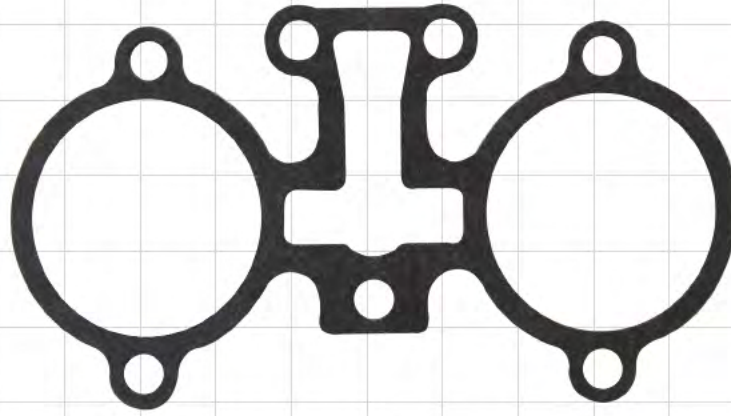

3 130

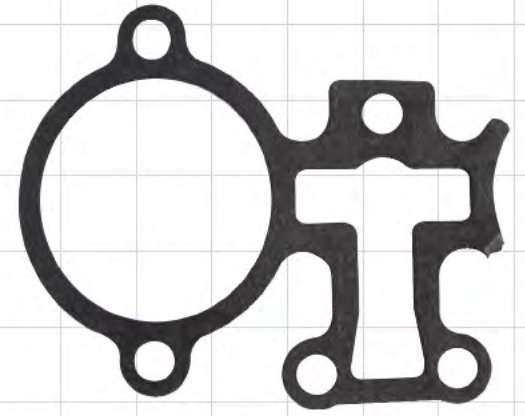

3 131



3 135

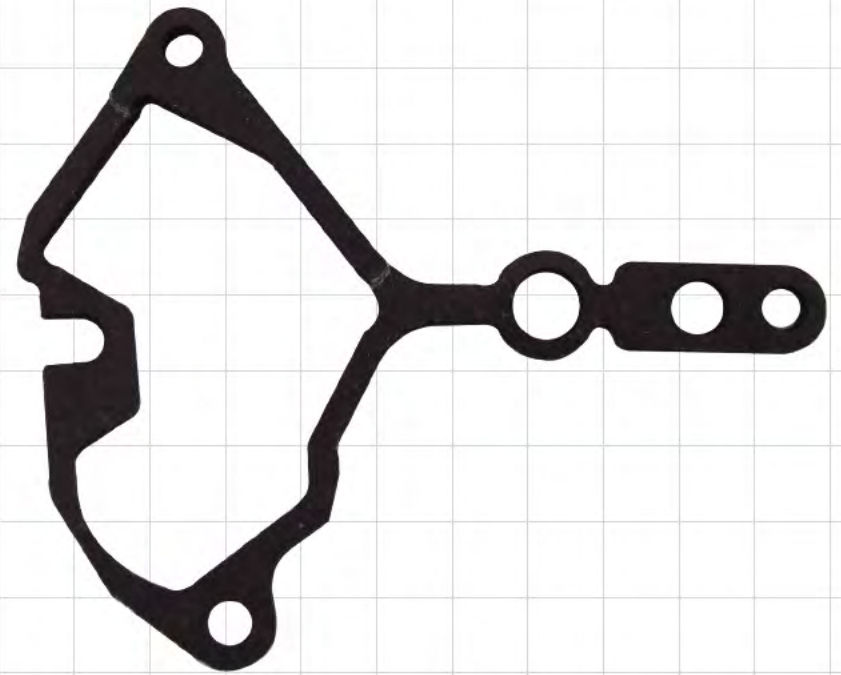

3 170

Adaptadores y Conexiones



235 581



207 634
8x1

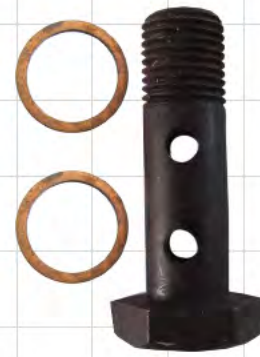

207 638
12x1.5



207 851
14x1.5



200 338



207 272



235 590



200 50



207 441



207 442
10 mm



207 443
12 mm



FAMILIA No. 937 Remache Flor para Materiales Blandos

Milimétrico

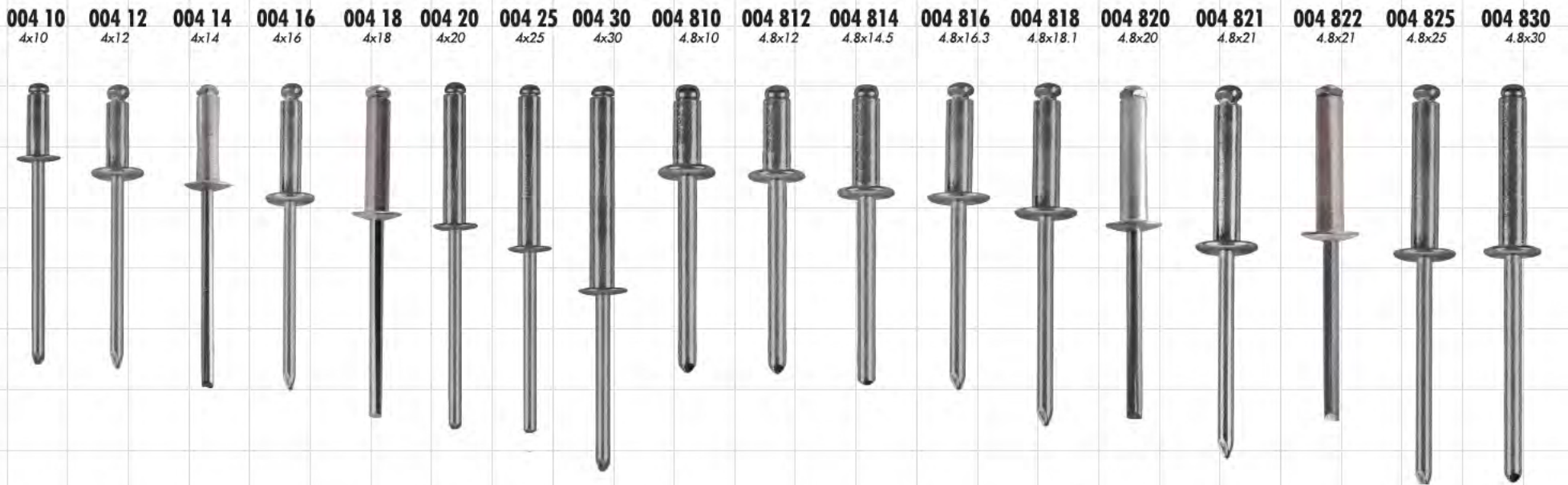

FAMILIA No. 915 Remaches

Ala Ancha

Cónicos

004 835
4.8x35

004 840
4.8x40

048 64
4.8x10

048 127
4.8x17

048 198
4.8x25

32 48
3.2x8

32 80
3.2x11

540 64
4x10

540 96
4x13

548 110
4.8x15

548 198
4.8x25

594 064

940 96



Cabeza Remachada



FAMILIA No. 914 Remaches para Partes Blandas

FAMILIA No. 935 Remache de Aluminio Blanco

FAMILIA No. 936 Remache de Aluminio Negro

40 64

48 64

48 198

048 50

048 100

18 216

18 416

18 516

18 616

18 216

18 416

18 516

18 616

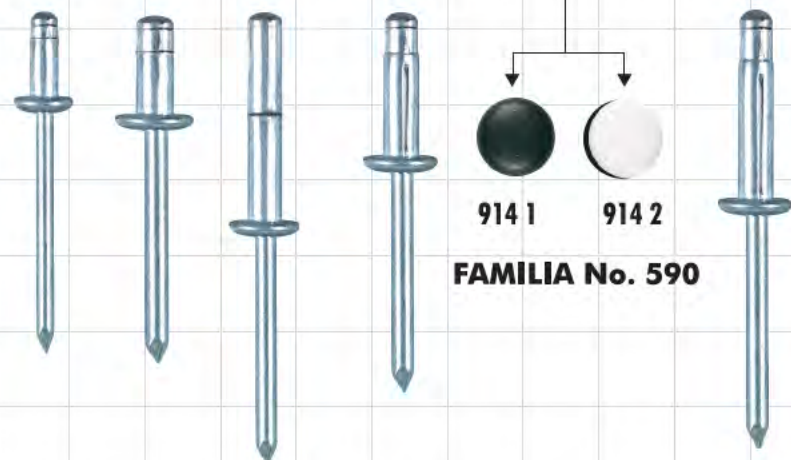

914 1 914 2

FAMILIA No. 590

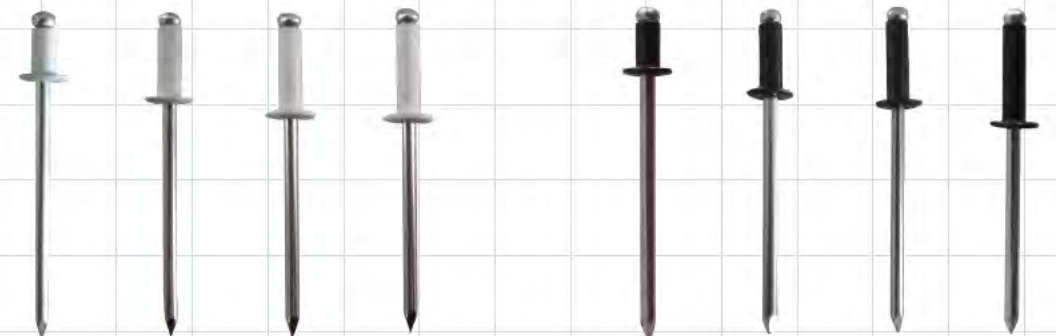

Cabeza Remachada

**FAMILIA N° 082 Tornillo Allen de Acero Fosfatado
DIN 912 Clase 8.8 Grado 5**

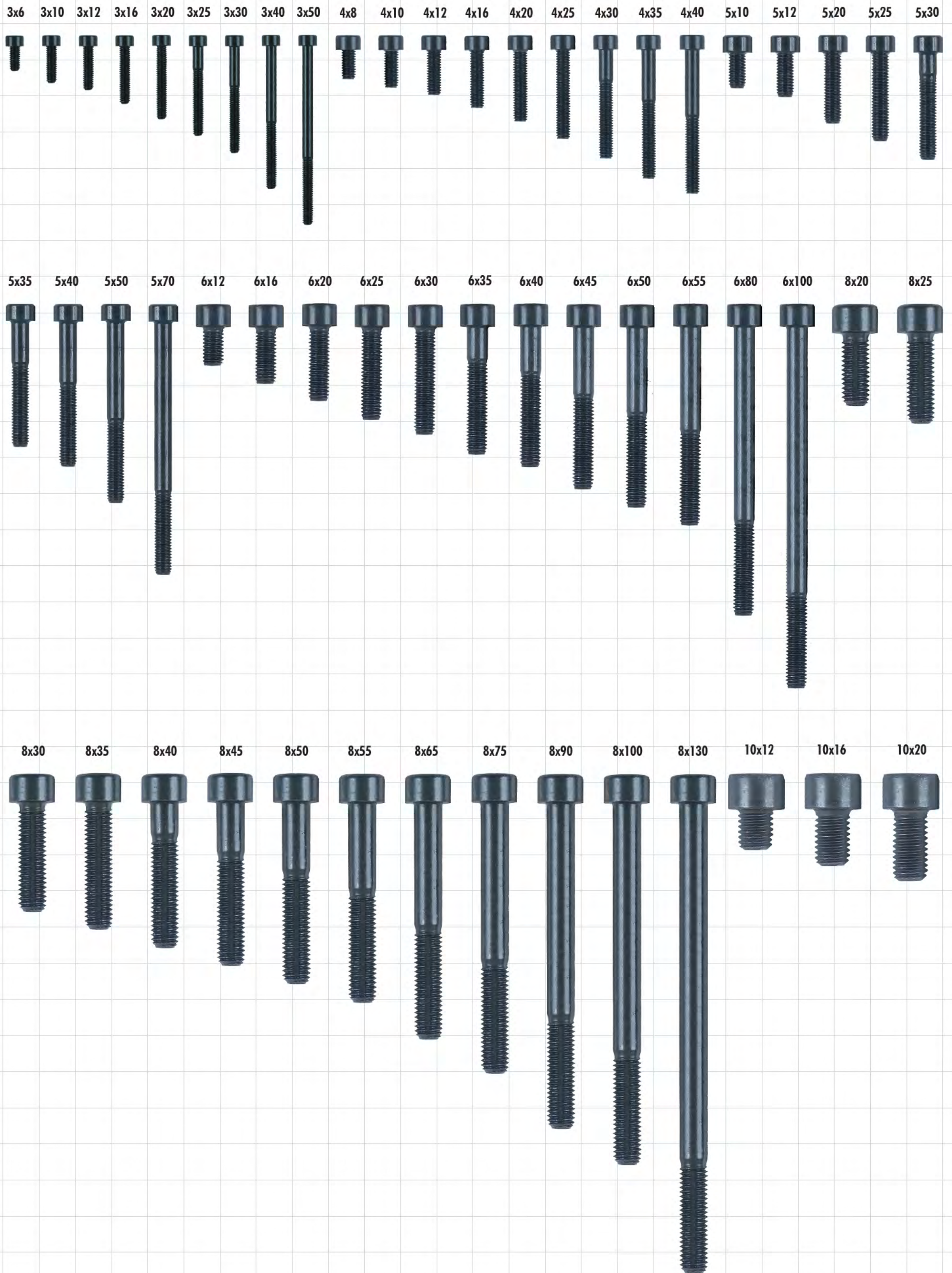

FAMILIA No. 938 Remache de Clavo (POP)

Milimétricos

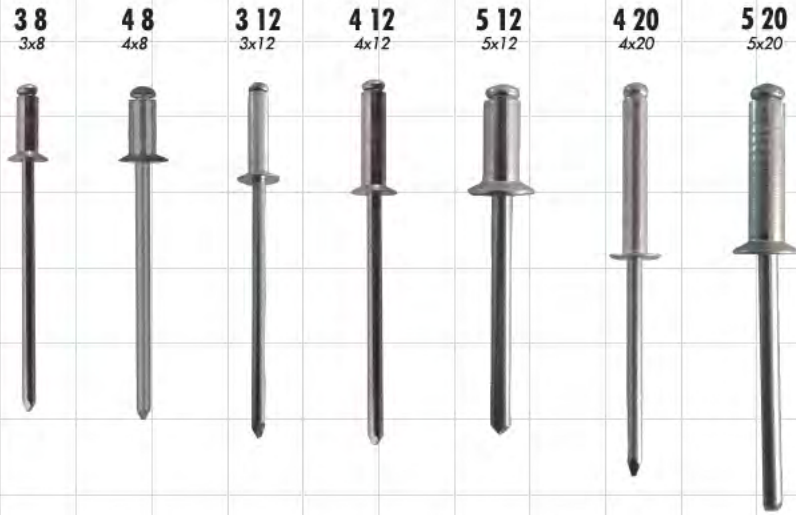

1/8 de Pulgada



5/32 de Pulgada



FAMILIA No. 921 Perno Ciego (Remache MonoBolt)

3/16 de Pulgada



1/4 de Pulgada



065 95



65 95



65 159



FAMILIA No. 917 Bujes Remachables y Componentes



FAMILIA No. 903 Componentes de Anclaje Milimétricos (Químicos, Plásticos y Metálicos)

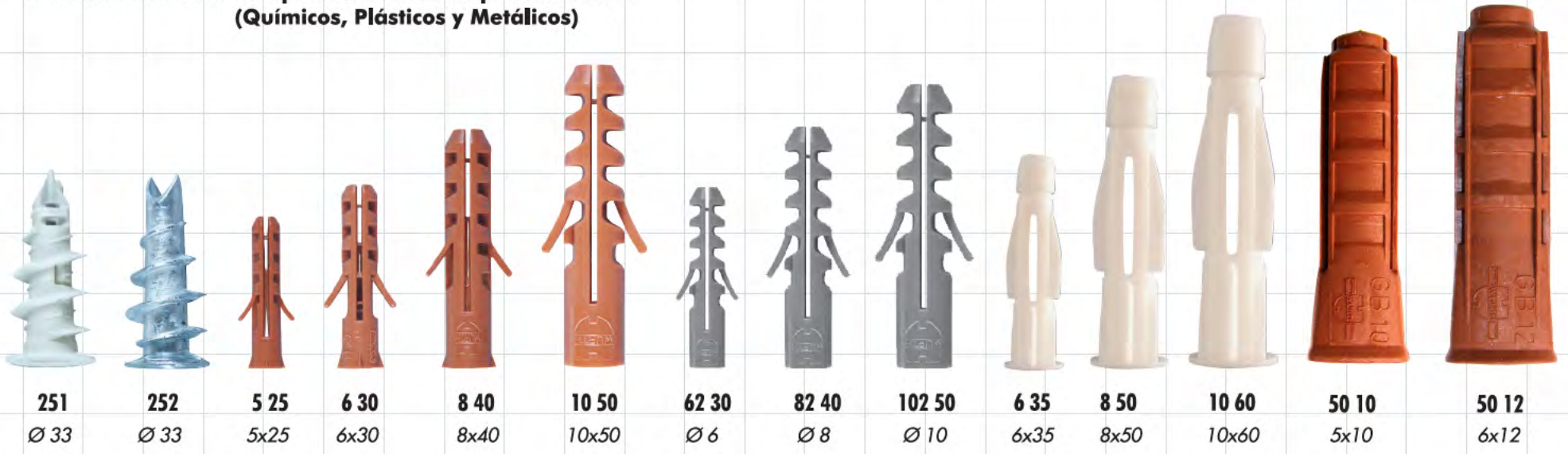

251 Ø 33	252 Ø 33	5 25 5x25	6 30 6x30	8 40 8x40	10 50 10x50	62 30 Ø 6	82 40 Ø 8	102 50 Ø 10	6 35 6x35	8 50 8x50	10 60 10x60	50 10 5x10	50 12 6x12
--------------------	--------------------	---------------------	---------------------	---------------------	-----------------------	---------------------	---------------------	-----------------------	---------------------	---------------------	-----------------------	----------------------	----------------------

Canastilla para Anclaje Químico (903 415 150)



Art. No.	Ø ext. mm	Ø ext. plgds.	Ø int. mm	Ø int. plgds.	Long. mm	Ø Broca
44 161	15	19/32	13	1/2	130	15
44 120	12	15/32	10	13/32	50	12
44 160	15	19/32	13	1/2	85	15
44 200	20	13/16	17	11/16	85	20

FAMILIA No. 905 Taquete Químico y Complementos (Ampolleta)



410 12

D. 12 mm
L. 160 mm

410 14

D. 14 mm
L. 170 mm

410 16

D. 16 mm
L. 190 mm

FAMILIA No. 879 Herramienta para Vulcanizado



315
Montador de Válvulas

Válvulas para Camión



572
3.75"

573
4.38"

Válvulas para Neumático

Válvulas Enkey



496
3/4

497
1 1/4

413
11.5x43

414
11.5x48.5

418
11.5x61.5

559

560

561



314



316

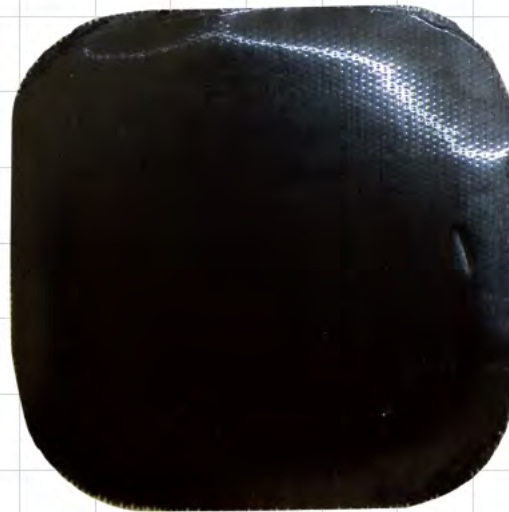

317

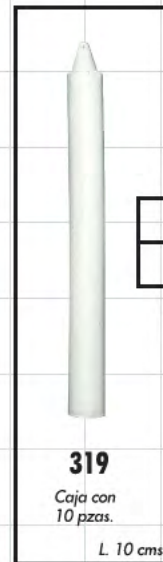

319
Caja con 10 pzas.
L. 10 cms

Art. No.	Color
879 318	

Caja con 10 pzas.



604



921



410 9



92
Paquete con 5 pzas.
L. 100 mm

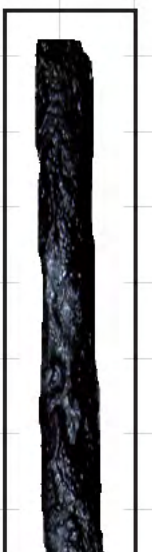

93
Paquete con 10 pzas.
L. 185 mm

FAMILIA No. 673 Discos Abrasivos de Vellón

23 50



205 010



205 018



215 040

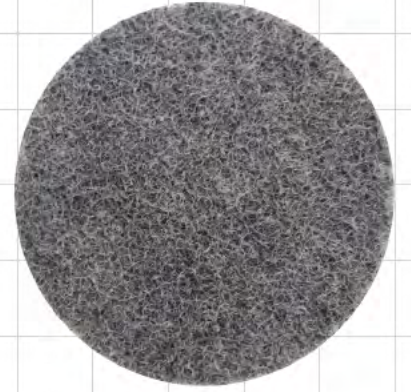

205 028

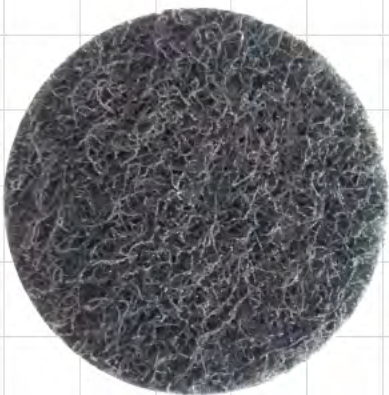

205 040

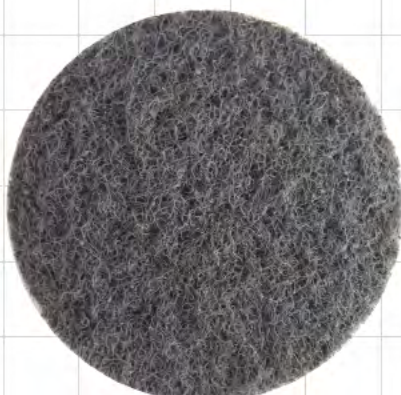

22 50

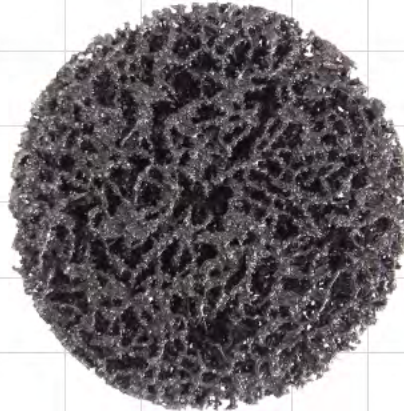

22 75



207 540



207 528



207 510



207 518



217 540



23 75



FAMILIA No. 580 Disco Mini Abrasivo Vulcanizado de Zirconio

005 040

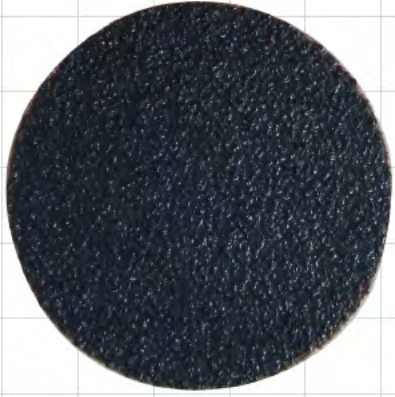

005 080



005 060

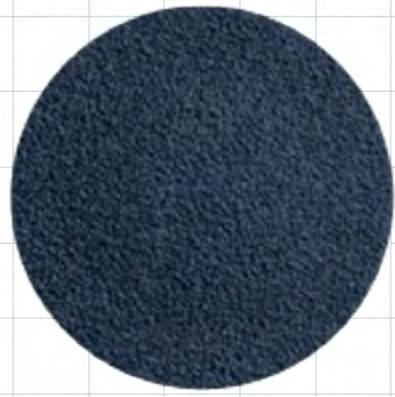

005 012

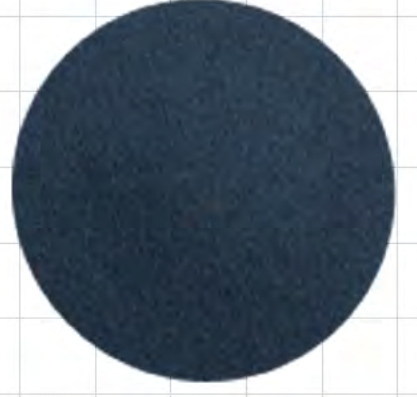

005 036

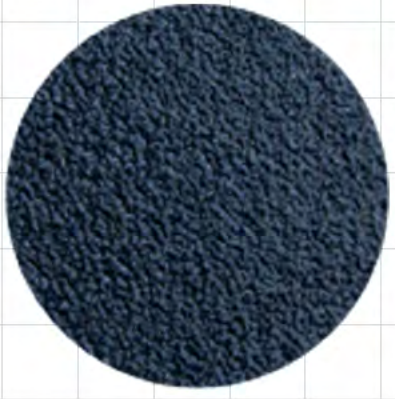

007 540



007 560

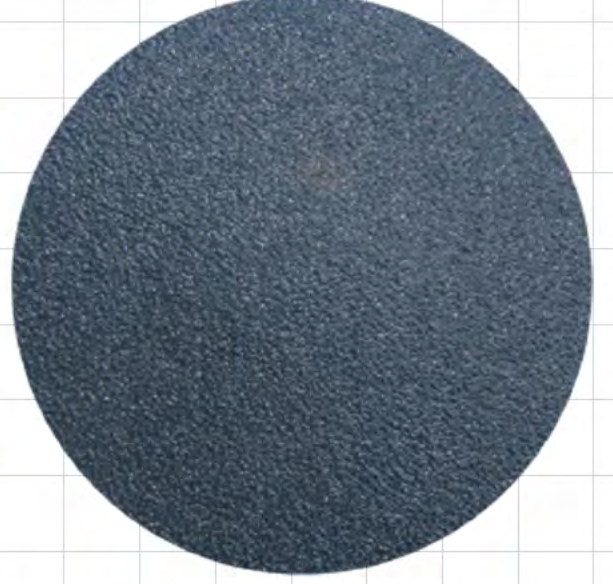

007 580



007 512



007 536

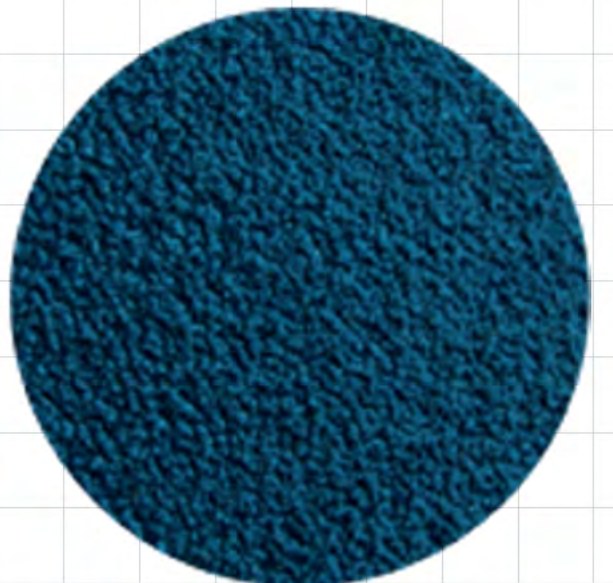

FAMILIA No. 586 Discos Abrasivos y Complementos

421 0



422 0

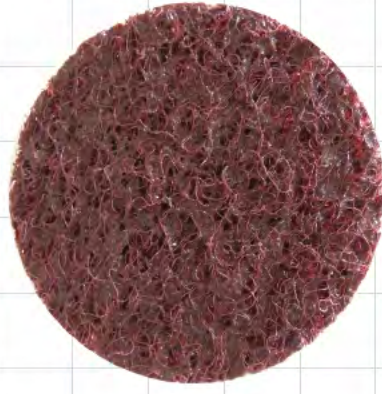

423 0

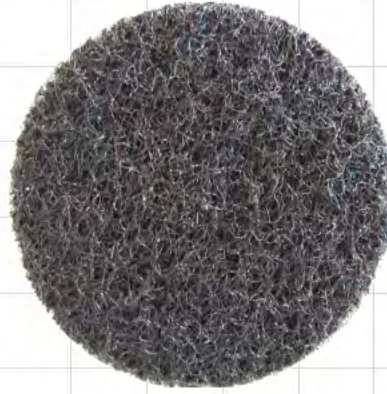

432 0



433 0



431 0



420 0



430 0

**FAMILIA No. 667 Discos de Corte Mini Fine**

007 508



0.8 mm de grosor

007 510

**FAMILIA No. 585 Cojinete para Pulido**

29 95



FAMILIA No. 955 Estuches de Almacenamiento (SISTEMA ORSY)

020 625



150 112



150 116



150 118



Art No. 962 60 Estantería con 60 Cajones



150 cms

60 cms

Art No. 955 100 Armario ORSY para 4 Estuches

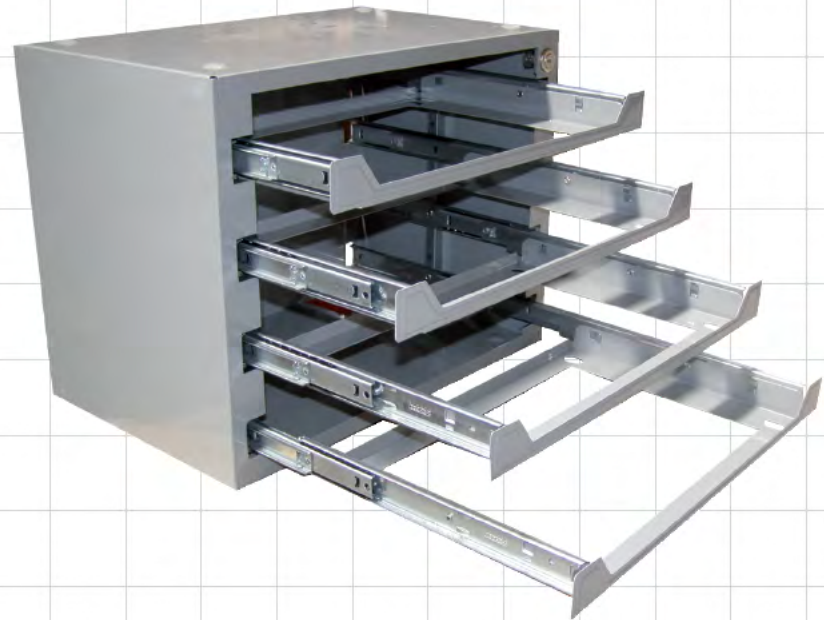

Art No. 961 2 3 Cajón para Estantería

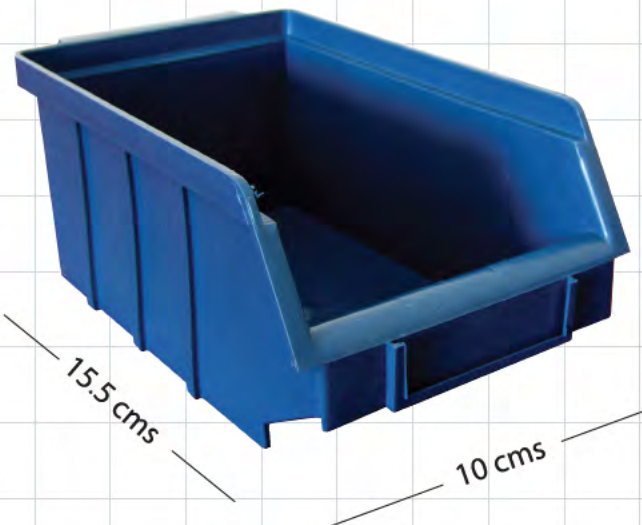

15.5 cms

10 cms

7 cms

FAMILIA N° 082 Tornillo Allen de Acero Fosfatado
DIN 912 Clase 8.8 Grado 5

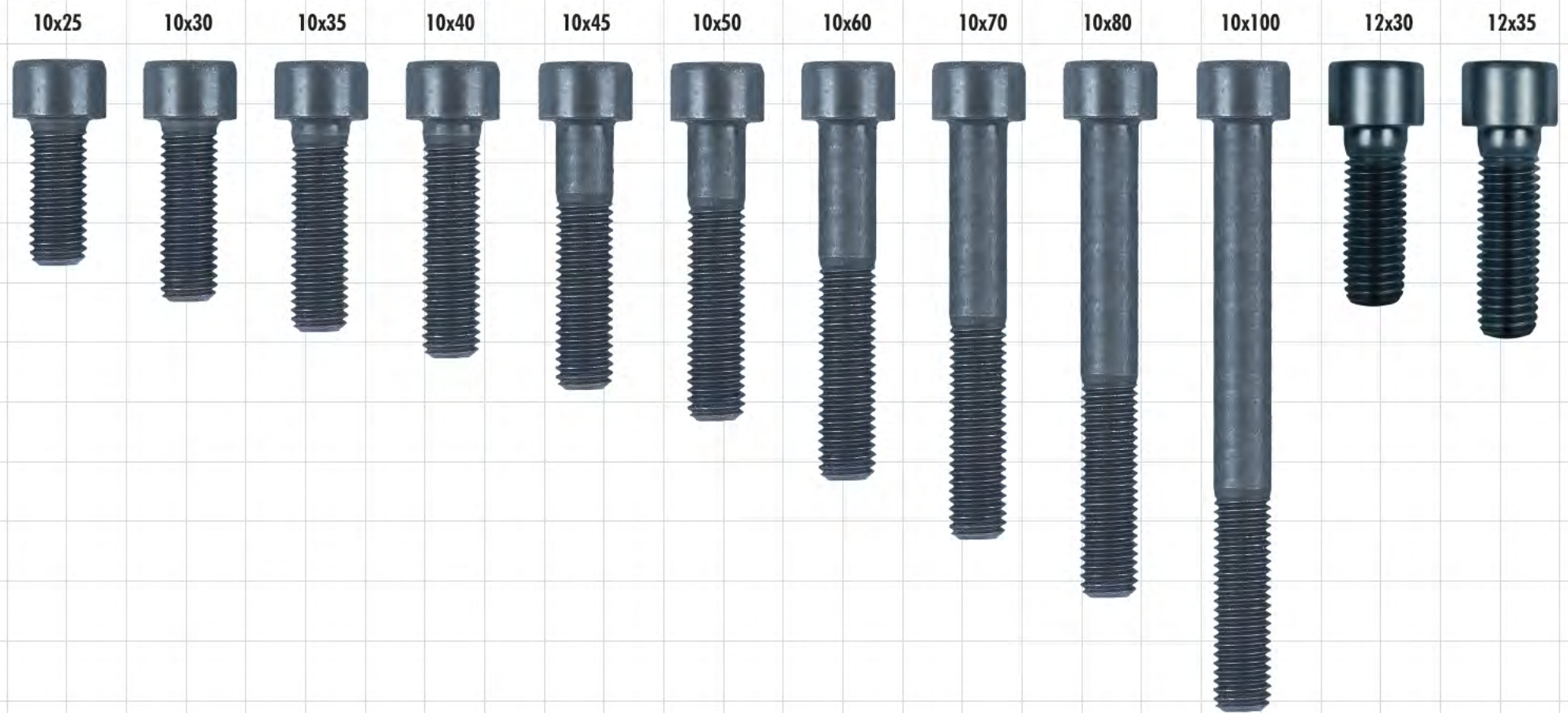

FAMILIA N° 086 Tornillo Allen de Acero Cincado
DIN 6912 Versión Cabeza Corta Con Espiga Int.



FAMILIA N° 274 Tornillo Hexagonal de Acero Bicromatado con Rondana de Seguridad Fija Clase 8.8 Grado 5



FAMILIA N° 096 Tornillo Hexagonal de Acero Inoxidable DIN 933 A2-70

Art. No.	Diámetro (mm)	Longitud (mm)	Paso
00096 4 10	4	10	0,7
00096 4 16	4	16	0,7
00096 4 20	4	20	0,7
00096 4 25	4	25	0,7
00096 4 30	4	30	0,7
00096 5 10	5	10	0,8
00096 5 12	5	12	0,8
00096 5 16	5	16	0,8
00096 5 20	5	20	0,8
00096 5 25	5	25	0,8
00096 5 30	5	30	0,8
00096 5 35	5	35	0,8

Art. No.	Diámetro (mm)	Longitud (mm)	Paso
00096 6 12	6	12	1
00096 6 16	6	16	1
00096 6 20	6	20	1
00096 6 25	6	25	1
00096 6 30	6	30	1
00096 6 35	6	35	1
00096 6 40	6	40	1
00096 8 16	8	16	1,25
00096 8 20	8	20	1,25
00096 8 25	8	25	1,25
00096 8 30	8	30	1,25
00096 8 35	8	35	1,25

Art. No.	Diámetro (mm)	Longitud (mm)	Paso
00096 8 40	8	40	1,25
00096 10 20	10	20	1,5
00096 10 25	10	25	1,5
00096 10 30	10	30	1,5
00096 10 35	10	35	1,5
00096 10 40	10	40	1,5
00096 10 50	10	50	1,5
00096 12 30	12	30	1,75
00096 12 40	12	40	1,75
00096 12 50	12	50	1,75
00096 12 60	12	60	1,75



FAMILIA N° 048 Tornillo Cónico Cruz (Phillips) de Acero Cincado DIN 965 Clase 4.8 Grado 2

Art. No.	Diámetro (mm)	Longitud (mm)	Paso
00048 3 6	3	6	0,5
00048 4 16	4	16	0,7
00048 4 20	4	20	0,7
00048 4 25	4	25	0,7
00048 4 40	4	40	0,7
00048 4 50	4	50	0,7
00048 5 10	5	10	0,8
00048 5 16	5	16	0,8

Art. No.	Diámetro (mm)	Longitud (mm)	Paso
00048 5 20	5	20	0,8
00048 5 25	5	25	0,8
00048 5 30	5	30	0,8
00048 5 40	5	40	0,8
00048 6 10	6	10	1
00048 6 16	6	16	1
00048 6 20	6	20	1
00048 6 30	6	30	1

Art. No.	Diámetro (mm)	Longitud (mm)	Paso
00048 6 40	6	40	1
00048 6 50	6	50	1
00048 8 10	8	10	1,25
00048 8 20	8	20	1,25
00048 8 30	8	30	1,25
00048 8 40	8	40	1,25
00048 8 50	8	50	1,25



FAMILIA N° 100 Tornillo Cónico Allen de Acero Inoxidable T. 304 DIN 7991

Art. No.	Diámetro (mm)	Longitud (mm)	Paso
00100 4 10	4	10	0,7
00100 4 12	4	12	0,7
00100 4 16	4	16	0,7
00100 4 20	4	20	0,7
00100 4 30	4	30	0,7
00100 4 35	4	35	0,7
00100 5 10	5	10	0,8
00100 5 12	5	12	0,8

Art. No.	Diámetro (mm)	Longitud (mm)	Paso
00100 5 16	5	16	0,8
00100 5 20	5	20	0,8
00100 5 30	5	30	0,8
00100 5 35	5	35	0,8
00100 6 10	6	10	1
00100 6 10	6	10	1
00100 6 12	6	12	1
00100 6 16	6	16	1

Art. No.	Diámetro (mm)	Longitud (mm)	Paso
00100 6 20	6	20	1
00100 6 25	6	25	1
00100 6 30	6	30	1
00100 8 20	8	20	1,25
00100 8 30	8	30	1,25
00100 10 30	10	30	1,5
00100 10 40	10	40	1,5
00100 10 50	10	50	1,5



FAMILIA N° 089
Tornillo Cónico Allen de Acero Fosfatado
DIN 7991 Clase 10.9 Grado 8

Art. No.	Diámetro (mm)	Longitud (mm)	Paso
00089 4 8	4	8	0,7
00089 4 12	4	12	0,7
00089 5 8	5	8	0,8
00089 5 10	5	10	0,8
00089 6 10	6	10	1
00089 6 20	6	20	1
00089 8 20	8	20	1,25
00089 8 25	8	25	1,25



FAMILIA N° 282
Tornillo Cónico Cruz Cabeza de Gota de Acero Cincado DIN 966

Art. No.	Diámetro (mm)	Longitud (mm)	Paso
00282 5 25	5	25	0,8
00282 8 25	8	25	1,25



FAMILIA N° 094
Tornillo Allen de Acero Inoxidable
DIN 912 A2-70

Art. No.	Diámetro (mm)	Longitud (mm)	Paso
00094 4 10	4	10	0,7
00094 4 16	4	16	0,7
00094 4 20	4	20	0,7
00094 5 10	5	10	0,8
00094 5 12	5	12	0,8
00094 5 16	5	16	0,8
00094 5 20	5	20	0,8
00094 5 25	5	25	0,8
00094 6 10	6	10	1

Art. No.	Diámetro (mm)	Longitud (mm)	Paso
00094 6 12	6	12	1
00094 6 16	6	16	1
00094 6 20	6	20	1
00094 6 25	6	25	1
00094 6 30	6	30	1
00094 6 35	6	35	1
00094 6 40	6	40	1
00094 6 45	6	45	1
00094 8 16	8	16	1,25

Art. No.	Diámetro (mm)	Longitud (mm)	Paso
00094 8 20	8	20	1,25
00094 8 25	8	25	1,25
00094 8 30	8	30	1,25
00094 8 35	8	35	1,25
00094 8 40	8	40	1,25
00094 8 50	8	50	1,25
00094 10 30	10	30	1,5
00094 10 40	10	40	1,5



FAMILIA N° 082
Tornillo Allen de Acero Fosfatado
DIN 912 Clase 8.8 Grado 5

Art. No.	Diámetro (mm)	Longitud (mm)	Paso
00082 12 190	12	190	1,75
00082 16 40	16	40	2
00082 16 60	16	60	2
00082 16 65	16	65	2
00082 16 70	16	70	2
00082 16 100	16	100	2
00082 16 120	16	120	2
00082 20 45	20	45	2,5
00082 20 65	20	65	2,5
00082 20 140	20	140	2,5
00082 20 150	20	150	2,5